



Material Handling and Port Operations Tires

Technical Databook

Preface

This data book contains comprehensive information on our Material Handling and Port Operations tire range. We recommend checking and adjusting the inflation pressure of every tire regularly. Incorrect inflation pressure, greater loads, excessive distances, and higher speeds than those recommended by the vehicle or tire manufacturer may shorten the service life of the tire or result in premature failure. These instructions must be followed in order to guarantee tire and vehicle safety. For further information, please see our safety instructions.

Continental's Material Handling and Port Operations tires are produced in accordance with internationally accepted standards established by ETRTO (European Tire and Rim Technical Organisation), TRA (Tire and Rim Association), JATMA (Japan Automobile Tire Manufacturers Association) and/or ISO (International Standards Organisation). These standards apply to a wide range of characteristics, including load capacity, inflation pressure, overall diameter, overall width, and associated valves and rims. In case of differences between these standards, Continental works according to the most appropriate standard available.

Publisher's notice

The content of this publication is provided for information only and is subject to change. Continental Reifen Deutschland GmbH provides no guarantees regarding the accuracy, reliability, completeness or up-to-dateness of the information provided in this publication. Continental Reifen Deutschland GmbH may, at its sole discretion, revise the information contained herein at any time without notice. Continental Reifen Deutschland GmbH's obligations and responsibilities regarding its products are governed solely by the agreements under which they are sold. Unless otherwise agreed in writing, the information contained herein does not constitute part of said agreements.

This publication does not contain any guarantee or agreement of quality regarding Continental Reifen Deutschland GmbH's products, nor any warranty of merchantability, fitness for a particular purpose or non-infringement. Continental Reifen Deutschland GmbH reserves the right to make changes to the products or services described in this publication at any time without notice.

This publication is provided on an "as is" basis. To the extent permitted by law, Continental Reifen Deutschland GmbH provides no guarantee, either express or implied, and assumes no liability with regard to the use of the information contained in this publication. Continental Reifen Deutschland GmbH is not liable for any direct, indirect, incidental, consequential or punitive damages arising from the use of this publication. The information contained herein is not intended as a declaration of product availability anywhere in the world.

The trademarks, service marks and logos (the Trademarks) displayed in this publication are the property of Continental Reifen Deutschland GmbH and/or its affiliates. Nothing in this publication should be construed as granting any license or right to the Trademarks. Without the express written consent of Continental Reifen Deutschland GmbH, the use of the Trademarks is prohibited. All text, images, graphics and other materials in this publication are subject to the copyright and other intellectual property rights of Continental Reifen Deutschland GmbH and/or its affiliates. Continental Reifen Deutschland GmbH owns the copyrights to the selection, coordination and arrangement of the materials in this publication.

These materials are not permitted to be modified or copied for commercial use or distribution.
© 2023 Continental Reifen Deutschland GmbH. All rights reserved.

Material Handling and Port Operations Tire Portfolio

Product Solutions	7
Vehicle-Tire Matrix - Material Handling Tires	8
Tire-Vehicle Fitment - Material Handling Operations	10
Vehicle-Tire Matrix - Port Operations	12

Tire Measurement

Tire Costruction and Classification Types	14
Units of Measurement and Definitions (DIN 70020)	15
Explanation of Tire Measurement	16

Tire Sidewall and Standards

Tire Markings and Sidewall Designation - Solid Tires	17
Tire Markings and Sidewall Designation - Press-on Bands	18
Compound Type and Rim Versions	19
Non Marking versus Conduivity	20
Tire Sidewall - Industrial Radial Pneumatic Tires	22
Tire Sidewall - Industrial Cross-ply Pneumatic Tires	23
Tire Sidewall - Port Operations Tires	24
Usage Designation including Tread Design and Depth	26
Load Index and Speed Symbol	27
Cyclic Service	28
Load Capacity Adjustments for Industrial Pneumatic Tires by Vehicle Type	29
Load Capacity Adjustment for Industrial Solid Tires mounted on Pneumatic Rims	30

Tire Construction

Tire Construction	31
Solid Tire Construction	32

Steel Wire Reinforced Construction 33

Steel Base Construction 34

Radial Tire Construction 35

Cross-ply Tires Construction (X-ply and V.ply) 36

Continental V.ply Technology for Material Handling and Port Operations Tires 37

Performance Matrix - Port Operations Tires - Radial vs. V.ply 38

Products and Technical Data

Technical Data Introduction 39

Continental Super Elastic Tires 40

Technical Data Super Elastic Tires 44

Technical Data Press-on-Bands 68

Industrial Radial Pneumatic Tires 80

Technical Data Radial Pneumatic Tires 84

Industrial Cross-Ply Pneumatic Tires 102

Technical Data Cross-Ply Pneumatic Tires 104

Port Operations Tires - V.ply 120

Technical Data Port Cross-Ply Tires 122

Port Operation Tires - Radial 132

Technical Data Port Radial Tires 134

Accessories and Technical Data

Tubeless Sealing Ring (TSR) Introduction 140

The Principle 141

Mounting Steps 142

Valves fitted on TSR	143
Tubes - Article Overview	144
Tubes - Explanation	145
Tubes - Valve Overview	146
Flaps - Article Overview	150
Flaps - Explanation	151
Special Accessories	152
Valves with special Layout and Additions	154
O-Ring	155
Set of SIT Rings for Mounting and Removal	156

Digital Tire Monitoring

Introduction Digital Tire Monitoring	157
Digital Tire Monitoring - Solutions	158
Vehicle Solutions	160

Tire Maintenance and Care

Product Service and Support	164
Tread Wear Indicator (TWI) and Tread Depth Measurement	166
Tire Pressure Maintenance	174
Regrooving of Solid Tires	176
Storage and Handling of Tires	179

Rims

Rim Types	180
Rim Identification	181
Rims for Press-on Bands acc. to DIN 7845/ETRTO	182

Dual Fitment

What is Dual Fitment? 184

ESH and Sustainability

REACH, SVHC and Sustainability 185

Product Solutions



More than 150 years of experience in the research, development and production of tires make Continental one of the world's leading tire manufacturers. Our range comprises a wide spectrum of high-quality products for virtually every kind of mobility, from the smallest featherweight competition cycle tires right through to large OTR tires and high-tech Formula E racing tires.

One of our greatest areas of expertise is tires for material handling and port vehicles. This represents an essential component of an industrial segment that is vital in safeguarding the production and supply chain of commercial goods and food.

Continental's solution for material handling tires features pneumatic bias and radial tires, as well as solid tires and press-on bands. These tires are fitted on a wide range of vehicles, including forklifts, warehouse equipment, airport pushbacks and tow tractors, as well as specialist, bespoke industrial transport equipment. Our expertise in this segment is reflected in the wide range of leading original equipment manufacturers who have fitted our tires and value them for their high mileage, extreme durability and endurance, and the class-leading

efficiency they provide thanks to their low rolling resistance values.

Our port operation tires have been developed especially for the demanding port and terminal industry, where high levels of productivity and maximum uptime are required in order to keep the port and terminal operations running seamlessly, smoothly and safely. Continental port radial and bias tires offer high performance on straddle carriers, reachstackers, empty container handlers, port terminal tractors, and even the latest generation of handling vehicles: automated guided vehicles (AGVs).







In addition to being a top-class tire manufacturer Continental also offers a wide range of smart technology and digital solutions that can analyze every tire movement, noting changes in pressure and heat over time. This allows us to combine information that is seconds old with our own extensive experience. This knowledge forms the core of our advice and consulting services as we help you choose the best tire for you from our huge portfolio, so you can make the maximum return on your tire assets in line with the requirements of your individual business.

All this is backed up by a worldwide sales and aftersales network as part of our customer support program, which provides you with efficient local service wherever you are located.

However, any tire - even premium products like ours - can only live up to its maximum potential and service life when properly maintained and used in accordance with standard operational practice. This technical data book is designed to provide both end users and manufacturers with the most important information, technical references and recommendations needed to help your Continental tires reach their maximum service life. In other words: this book is here to help you get the best out of your tires! Whether you're a driver, a fleet manager, part of a maintenance team or an operator, if you - and everyone else who comes into contact with our products - follow these instructions and recommendations correctly, you will be able to significantly improve your performance while at the same time reducing your overall operational costs and protecting the environment.

We offer the right tires for every application and requirement.

Vehicle-Tire Matrix - Material Handling Tires

Tire Construction			
Vehicle types	Cross-ply	Radial	Super Elastic
	IC40 	ContiRV20/ ContiRV20 All Season ContiRT20 	SC20+ & SC20 Clean 
Forklift (<18 t) - Counterbalanced 	●	●	●
Heavy Forklift (>18 t) - Counterbalanced 		●	●
Warehouse Trucks 			●
Industrial Aerial Lifting Equipment 			●
Pushback Tractors 	●	●	●
Industrial and Airport Tow Tractors 		●	●
Non-driven Industrial and Airport Equipment 			●
Side Loaders 	●	●	●

The above matrix applies to the majority of vehicles. Individual cases may vary.





● Preferred application For use in other applications, please contact your Sales representative

Tire Construction

Super Elastic		Press-on Bands		Vehicle types
<p>SC18 & SC18 Clean</p> 	<p>CS20+ & CS20 Clean</p> 	<p>ContiPT18 & ContiPT18 Clean</p> 	<p>MH20 & MH20 Clean</p> 	
	●		●	<p>Forklift (<18 t) - Counterbalanced</p> 
	●			<p>Heavy Forklift (>18 t) - Counterbalanced</p> 
	●		●	<p>Warehouse Trucks</p> 
	●		●	<p>Industrial Aerial Lifting Equipment</p> 
	●			<p>Pushback Tractors</p> 
	●			<p>Industrial and Airport Tow Tractors</p> 
	●		●	<p>Non-driven Industrial and Airport Equipment</p> 
				<p>Side Loaders</p> 

Tire-Vehicle Fitment - Material Handling Operations

— CLEAN	SOLID	› SC20 › SC18 › CS20 › SH12	› SC20 › SC18 › CS20 › SH12		› SC20 › SC18 › CS20 › SH12	
	POB	› ContiPT18 › MH20 › MC20	› ContiPT18 › MH20 › MC20		› ContiPT18 › MH20 › MC20	› ContiPT18 › MH20 › MC20
— BLACK	SOLID	› SC20 › SC18 › CS20 › SH12	› SC20 › SC18 › CS20 › SH12	› SC20 › SC18 › CS20 › SH12	› SC20 › SC18 › CS20	
	POB	› ContiPT18 › MH20 › MC20	› ContiPT18 › MH20 › MC20			› ContiPT18 › MH20 › MC20
	RADIAL	› ContiRV20 › ContiRT20 › IC70	› ContiRV20 › ContiRT20	› ContiRV20 › ContiRT20	› ContiRV20 › ContiRV20 AllSeason	
	X-PLY	› IC10 › IC12 › IC40	› IC10 › IC12 › IC40	› IC10 › IC12 › IC40	› IC10 › IC12 › IC40	
	V.PLY					

FORKLIFT < 3.5 T
FORKLIFT > 3.5 T
SIDELOADER
INDUSTRIAL TOW TRACTOR
FORKLIFT



<ul style="list-style-type: none"> › SC20 › SC18 › CS20 › SH12 					
<ul style="list-style-type: none"> › ContiPT18 › MH20 › MC20 					
<ul style="list-style-type: none"> › SC20 › SC18 › CS20 › SH12 		<ul style="list-style-type: none"> › SC20 › SC18 › CS20 › SH12 › CT Trailer 			
<ul style="list-style-type: none"> › ContiPT18 › MH20 › MC20 		<ul style="list-style-type: none"> › ContiPT18 › MH20 › MC20 			
	› ContiRT20		<ul style="list-style-type: none"> › ContiRV20 › ContiRT20 › ContiRV20 AllSeason › TerminalMaster 	› ContiRT20	
	› IC40		<ul style="list-style-type: none"> › IC10 › IC12 › IC40 	› IC40	
				› TerminalMaster V.ply	

BLACK
 CLEAN

WORKING PLATFORM

SPMT

TRAILER

TOW TRACTOR (AIRPORT)

PUSHBACK

	Radial					X-Ply		V.Ply
MC20	ContiRT20	ContiRV20	ContiRV20 AllSeason	IC70	TerminalMaster	IC10 IC12	IC40	TerminalMaster V.ply

Vehicle-Tire Matrix - Port Operations

Tire Construction					
Vehicle types	V.ply				Radial
	ContainerMaster+	DockMaster+	TerminalMaster	CraneMaster	ContiRT20 (24')
					
Heavy Forklift (>18 t) - Counterbalanced 	●	●			●
Empty Container Handlers 	●	●			●
Reachstackers 	●	●			●
Rubber-Tired Gantry Cranes (RTG) 				●	
Automated guided Vehicles (AGV) 	●		●		
Straddle/Shuttle Carriers 					
Terminal Tractors 					
Container Trailers 					
Terminal Roll Trailers/ Low-Platform Trailers 					

The above matrix applies to the majority of vehicles. Individual cases may vary.

● Preferred application For use in other applications, please contact your Sales representative

Tire Construction

Radial				Super Elastic	Press-on Bands	Vehicle types
StraddleMaster Radial	ContainerMaster Radial	TerminalMaster	Terminal Transport	Conti Trailer	MH20	
						
	●					Heavy Forklift (>18 t) - Counterbalanced 
	●					Empty Container Handlers 
	●					Reachstackers 
						Rubber-Tired Gantry Cranes (RTG) 
●						Automated guided Vehicles (AGV) 
●						Straddle/Shuttle Carriers 
		●	●			Terminal Tractors 
		●	●	●		Container Trailers 
					●	Terminal Roll Trailers/ Low-Platform Trailers 



Tire construction and classification types

The industrial and port operations business is characterized by a huge variety of different vehicles, ranging from small, one-ton warehouse trucks to large reachstackers with lifting capacities in excess of 100 tons operating in container port terminals. This vast

range of machines and applications calls for an equally portfolio of specialized tires differ in terms of their construction, tread design, compounds and other individual characteristics. The tire industry has developed different classifications in order to make it easier to identify the

right tire for the right combination of vehicle and application. The following pages provide an overview of the most important classification/designation types for industrial and port operations tires.

Units of Measurement and Definitions (DIN 70020)

The technical specifications given in the tables generally comply with international ETRTO and DIN standards. Additional information, such as further tire sizes or versions, together with the static radius, is provided in compliance with DIN or with WdK guidelines.

Lengths

Specified in millimetres (mm).

Tire pressure in “bar”

(Tire inflation) is specified as an overpressure in bar, and refers to the cold tire.

Tire pressure in “kPa”

Tire inflation.

Max. outer diameter of tire in service

Maximum permissible diameter in the tread center as a result of permanent growth during tire use.

Max. operational width

Maximum permissible width. This includes scuff ribs, decorative ribs, tire markings, and permanent growth during use.

Static radius

The distance from the stationary tire center level to the ground.

Actual value

The actual measurement of a Continental tire.

Rolling circumference

The road distance covered by a point on the tread during a single rotation of the wheel.

Control of measurements

Conducted on the fitted and inflated tire at calibration tire pressure according to DIN 70020, Sheet 5.

Load capacity

Specified in kgs (weight in the sense of a mass).

Super Elastic tires

These should always be interchangeable with pneumatic tires. The maximum measurements must therefore be taken when designing the fitting clearance.

The effective outer diameter of CSE tires is approximate. Also, rolling circumference increases for a deflected solid tire, and decreases for a pneumatic tire. It is 2% smaller than that of pneumatic tires. However, since the degree of deflection is lower, the static radius (rstat.) is approximately the same. Vehicle designers should bear in mind the maximum values for tire outer diameter and width when planning the wheel space of a vehicle, if they intend for standard approved tires to fit the vehicle without any restrictions. In exceptional circumstances where this is not possible, the resulting safety risk must be accounted for.

Explanation of Tire Measurement

Solid Tires

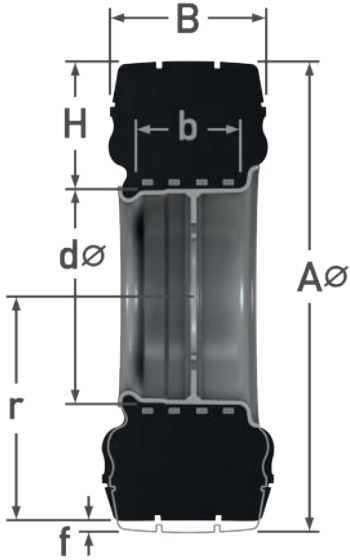

Aø	Tire outer diameter
Aø_{max.}	Max. tire outer diameter in service
B	Cross section width
B_{max.}	Maximum operational width
H	Tire section height
dø	Rim diameter
b	Rim width
f	Radial deflection
r	Static radius
H:B	Aspect ratio

Pneumatic Tires

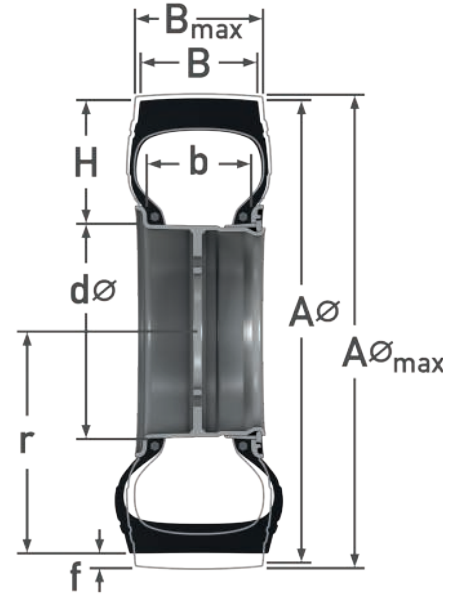

The dimensional data provided in this data book complies with ETRTO standards where applicable. Additional information, such as additional tire sizes not listed in ETRTO, is provided in compliance with DIN or WdK guidelines. All data is correct at the date of publication, but is subject to change and cannot be guaranteed.

Note: The in-service diameter is the maximum permitted dimension as a result of growth during tire use in operation.

Tire Markings and Sidewall Designation - Solid Tires

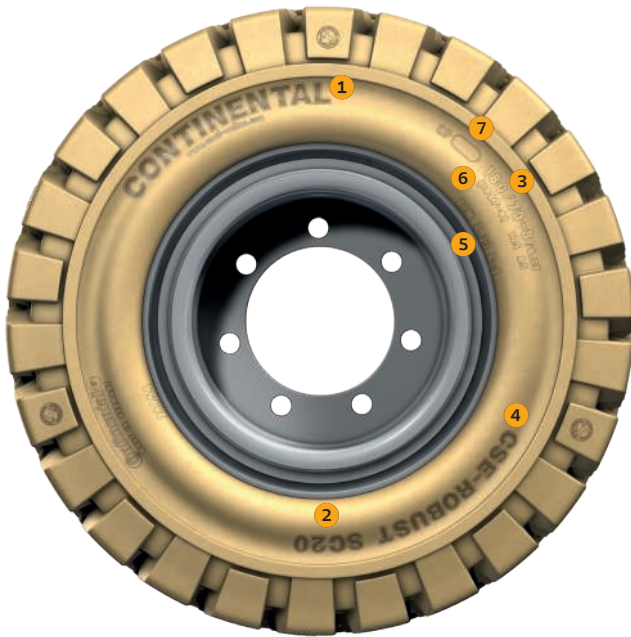

Description

1	Manufacturer	Continental
2	Product Name	SC20
3	Dimensions	180/70-8 /4.33
4	Construction	Super Elastic
5	Rim Size	4.33R-8
6	Load Index and Speed Symbol	125 A5
7	Production Date	(WW/YY)

Tire explanations (ECE-Standard)

Tire type & construction					Example tire size explanations					
Tire type	Size designation	Imperial description	Base version	Compound type	Load index/ Speed symbol	Outer diameter	Tire nominal width	Aspect ratio	Rim diameter	Rim width
Solid/CSE	180/70-8/4.33		SIT/S	Clean (light colored)	125 A5	-	180 mm	70%	8"	4.33"
		18x7-8/4.33	SIT/S	Robust (Black)	125 A5	18"	7"	-	8"	4.33"

All pictures shown are examples intended for illustrative purposes only. Size and construction of actual product may vary.

Tire Markings and Sidewall Designation - Press-on Bands



Description

1	Manufacturer	Continental
2	Product Name	ContiPT18
3	Dimensions	21 x 7 x 15
4	Construction	Press-on Band
5	Production Date	(WW/YY)

Tire explanations (ECE-Standard)

Tire type & construction					Example tire size explanations			
Tire type	Size designation	Imperial description	POB type	Compound type	Outer diameter	Tire width	Aspect ratio	Rim diameter
Press-on Band	200/75-100	-	STB	A (Robust)	200 mm	75 mm	-	100 mm
	-	16x6x10½	STB	Clean (Light colored)	16"	6"	-	10½"

For load carrying capacities please refer to actual technical data.

Compound Type

Type	Symbol	Application
L	L	Press-on tires with compound designed for free running and non-driven wheels.
A	A	Press-on tires with compound for driven and braked wheels. Compound is designed to withstand high tractive and torque forces.
A-ROBUST	A-ROBUST	Standard compound for Super Elastic black tires. The Continental robust black compounds offer low rolling resistance, reducing vehicle energy consumption and ensuring high durability and endurance in applications where loads are extreme and working times long.
ANTISTATIC (CONDUCTIVE)	↘ ANTISTATIC ↙	Special, electrostatically effective compound with an electrical resistance of less than $10^6 \Omega$. Note: Electrical contact between tire and rim must be ensured. Please note that prolonged contact with fluids that cause swelling (such as oil or solvents) reduces conductivity.
CLEAN	CLEAN	A non-marking compound designed for areas that are sensitive to dust and dirt. Thanks to the special tread compound and its light color, this can reduce visible tire marks on the floor and thus soiling of the production and storage areas.

Rim versions*

Tires with steel base

Tires with steel wire reinforcement



Cylindrical base (STB)



Cylindrical base (Z)



Tapered base, centre-split (km)



Tapered base, offset-split (ks)

Type

Version

A-ROBUST | L, A, ANTISTATIC



Tire base with steel rim or steel wire reinforcement

* Elastic wheels available on request



Non Marking versus Conductivity

Tires for use in sectors with strict cleanliness and safety requirements such as the chemical, pharmaceutical, automotive, solar, optical, food, paper, and aerospace industries represent a challenge for developers and engineers. Special clean tires are often used in these areas in order to reduce the contamination caused by tire tracks. At the same time, tires generate static electricity due to the friction caused during operation. This static electricity can lead to safety problems, injuries to drivers, damage to vehicles or plants, and breakdowns. To minimize the risk of injury and damage, the use of standard black or anti-static tires in addition to the vehicle grounding strip or chain is recommended.

What are the differences between clean, standard black and anti-static tires in terms of conductivity?



Clean Tires - Non-conductive

Clean tires are non-marking and therefore specially designed for areas that are sensitive to dust and dirt. Thanks to the special tread compound and its light color, they can reduce visible tire marks on the floor and thus soiling of the production and storage areas.



Standard Black Tires - Conductivity <math>< 10^{10} \Omega</math>

Standard black tires permanently transfer their accumulated static charge to the floor, thus minimizing the safety risk to man, machine and product. Continental recommends using anti-static tires instead of standard black tires in applications where static charge needs to be reduced or prevented.



Anti-Static Tires - Conductivity <math>< 10^6 \Omega</math>

Anti-static tires reduce risk of sudden electrical discharges to a minimum, thanks to a special rubber compound and special built-in designed for maximum conductivity. In combination with the vehicle, these can be used to create a permanently grounded system. In some sectors (e.g. the chemical industry), the use of anti-static tires is a regulatory requirement. The anti-static effect can also be achieved using a number of different grounding technologies on the vehicle itself, but the vehicle needs to be equipped for anti-static use. Continental recommends using anti-static tires rather than standard black tire in applications where static charge needs to be reduced or prevented.



Non-marking tires are non-conductive. When using non-marking tires, Continental recommends employing additional grounding technology on the vehicle to ensure the conductivity of the vehicle-tire-system, as we believe that the individual benefits of both tire solutions (non-marking and conductivity) outweigh the benefits of a combined solution. Please check the vehicle manufacturer's advice/instructions for grounding details.

Tire performance in comparison

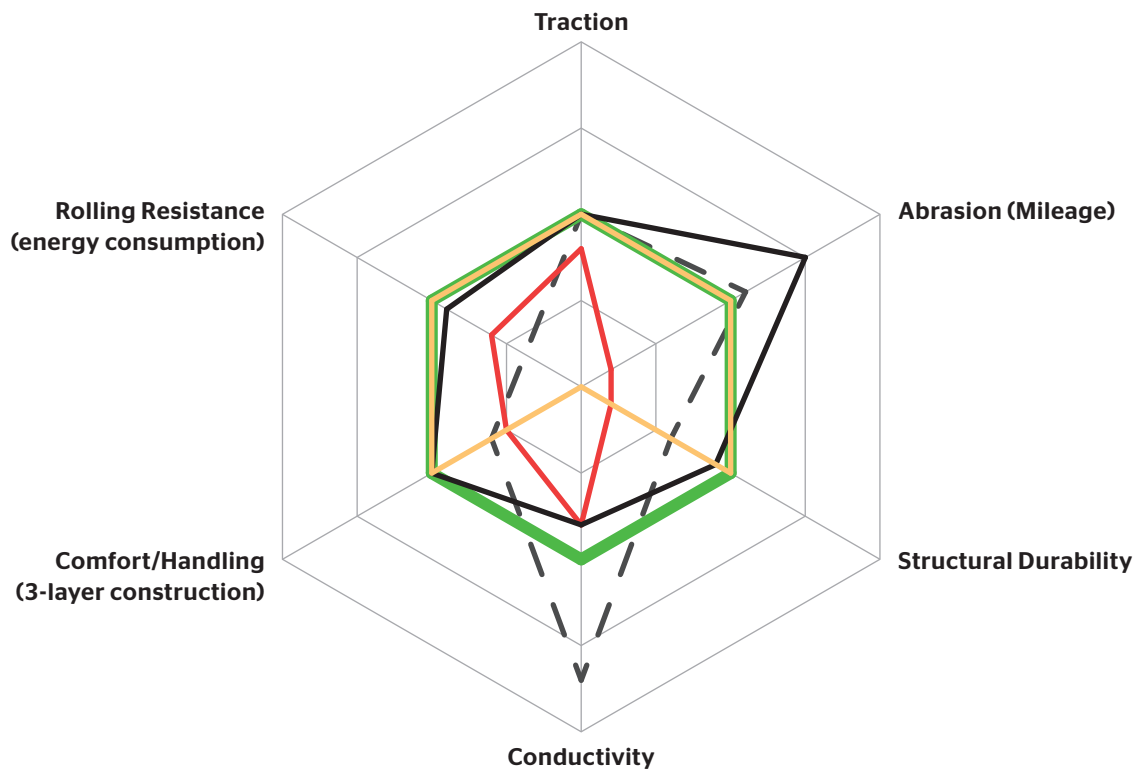

— SC20+ (Standard Black)
— SC20 Clean
- - SC20 Anti-Static
— SC20 Clean & Vehicle grounding
— Estimated conductive clean performance

Benefits of Clean Tires



- › Developed for areas that are sensitive to dust and dirt
- › Easy to spot thanks to their characteristically light colored rubber compound
- › Reduce visible tire marks on the floor and soiling of the production and storage areas to a minimum

Benefits of Standard Black/Anti-Static Tires



- › Most convenient feature for the user
- › Protect user, product and equipment from static electricity
- › Prevent uncontrolled electric discharges, which may cause dangerous sparks

If you have any further questions or comments, please contact your local Continental Sales Person or Technical Customer Services Representative. Performance based on SC20 Clean and vehicle grounding, all additional values in correlation.

Tire Sidewall - Industrial Radial Pneumatic Tires



Description

1	Manufacturer	Continental
2	Product Name	ContiRV20
3	Dimension	7.00 R12
4	Construction	Radial
5	Rim Diameter Code	12
6	Load Index and Speed Symbol	136 A5 16 PR
7	Tire Type	Velocity
8	TSR Information	Compatible with Continental TSR System

Tire explanations (ECE-Standard)

Tire type & construction			Example tire size explanations		
Tire type	Radial tire (R)	Load index/Speed symbol	Tire width	Aspect ratio	Rim diameter
Pneumatic	7.00 R 12	136 A5	7"	100%	12"
	180/70 R 8	125 A5	180 mm	70%	8"
	315/70 R 15	165 A5	315 mm	70%	15"

All pictures shown are examples intended for illustrative purposes only. Size and construction of actual product may vary.

Tire Sidewall - Industrial Cross-ply Pneumatic Tires



Description

1	Manufacturer	Continental
2	Product Name	IC40
3	Dimension	23 x 9-10
4	Rim Diameter Code	10
5	Load Index and Speed Symbol	142 A5
6	Ply Rating	20

Tire explanations

Tire type & construction				Example tire size explanations			
Tire type	Cross ply/ V-ply tire	Load index/ Speed symbol	Ply Rating (PR)	Outer diameter	Tire width	Aspect ratio	Rim diameter
Cross-ply	7.00-12	134 A5	14	-	7"	100%	12"
	23x5	113 A5	6	23"	5"	100%	13"
	18x7-8	125 A5	14	18"	7"	85%	8"
	300-15	165 A5	22	-	300 mm	70%	15"

All pictures shown are examples intended for illustrative purposes only. Size and construction of actual product may vary.

Tire Sidewall - Port Operations Tires

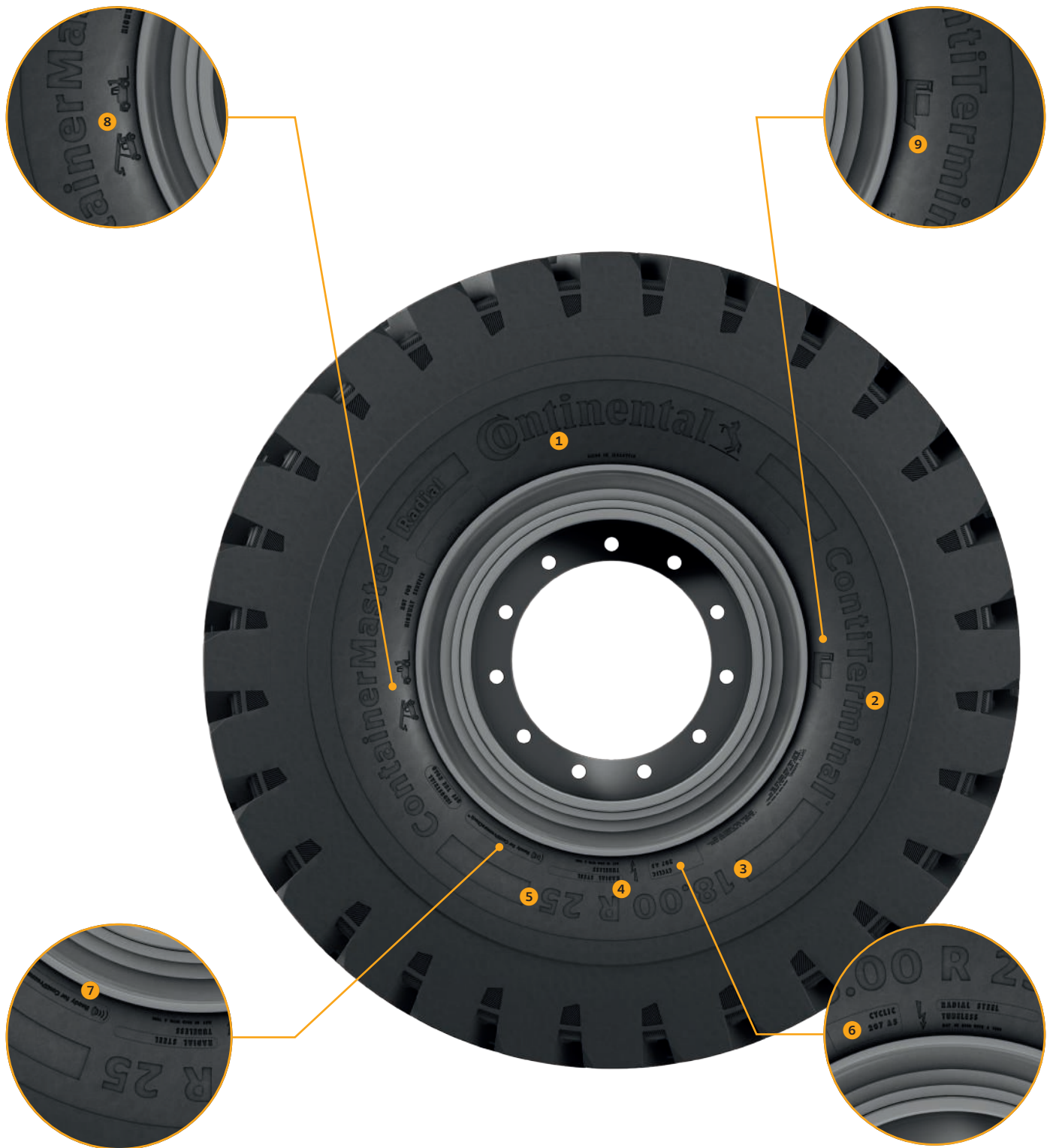

All pictures shown are examples intended for illustrative purposes only. Size and construction of actual product may vary.

Tire Sidewall - Port Operations Tires

Description

1	Manufacturer	Continental
2	Product Name	ContainerMaster Radial
3	Dimension	18.00-25
4	Construction	Radial
5	Rim Diameter Code	25
6	Load Index and Speed Symbol	207 A5
7	ContiPressureCheck	Equipped with sensor
8	Application (pictogram)	Reachstacker/Heavy Forklift
9	Tire Category (pictogram)	Harbor/Port

Tire explanations (ECE-Standard)

Tire type & construction					Example tire size explanations		
Tire type	Radial tire (R)	Rim type	Tread designation	Load index/ Speed symbol	Tire width	Aspect ratio	Rim diameter
Pneumatic	18.00 R 25	TL	E4	207/00 A5	18"	100%	25"

All pictures shown are examples intended for illustrative purposes only. Size and construction of actual product may vary.

Usage Designation* including Tread Design and Depth

All types of OTR tires used in port operations feature a letter and number coding. This represents the application type and the tread depth.

All port operations tires feature the letter code IND. IND indicates that the tire construction and compound is designed for "Industrial service" applications where the tire is used on hard flat surfaces such as concrete, asphalt, or interlocking bricks.

The number code that follows the letter code indicates the tread depth. The number 3 indicates a regular tread depth, which is defined as 100%. The number 4 indicates a deeper tread, defined as 150%. In some cases, the letter "S" may follow the number. This indicates the tire has a smooth or slick pattern. If no letter follows the number, the tire is automatically a block-type pattern.

Special markings on the sidewall of port operations tires help to identify the primary usage they are designed for.



This combination of letters and numbers is often called a TRA or EM-Code, and is an international classification system for OTR tires. The table below provides a rough overview of the different combinations.

TRA Classification/ EM-Code*	Tread Type (pattern design)	Application
IND-3	Industrial	IND = Industrial Service
IND-3S	Industrial Smooth	
IND-4	Industrial Deep Tread	
IND-4S	Industrial Smooth Deep Tread	

* In accordance with: ETRTO, TRA, JATMA and ISO

Operating instructions: DIN 7811, WdK-Guideline 211, WdK-Guideline 153, ETRTO

Load capacity. When determining the minimum tire size necessary for any particular wheel position on a vehicle, the approved load and the maximum design speed of the vehicle must always be used as a basis.

Tire pressure. The tire pressures provided in the tables are minimum tire pressures and should be used only as a guide. For special operating conditions specific tire pressures can be recommended. All tire pressures refer to tires in a "cold" condition after standing outdoors for several hours without exposure to intense sunlight.

Rims. Only the rims indicated are approved for fitment on new vehicle series.

Wheels. The load capacity must be adequate in all cases.

Load Index and Speed Symbol

Wdk guideline
See previous page

The maximum load that can be borne by a tire is indicated by the Load Index (LI). This tire LI is always related to a specific reference speed, which is indicated by the speed symbol. In addition to the reference speed, other application conditions can also be specified by the tire manufacturer. It is important to understand that changing service conditions and/or different vehicle speeds may impact the load-bearing capacity of the tire.

LI	[kg]	[lbs]*	LI	[kg]	[lbs]*	LI	[kg]	[lbs]*	LI	[kg]	[lbs]*	LI	[kg]	[lbs]*	LI	[kg]	[lbs]*
1	46.2	102	43	155	342	85	515	1135	127	1750	3858	169	5800	12787	211	19500	42990
2	47.5	105	44	160	353	86	530	1168	128	1800	3968	170	6000	13228	212	20000	44092
3	48.7	107	45	165	364	87	545	1202	129	1850	4079	171	6150	13558	213	20600	45415
4	50.0	110	46	170	375	88	560	1235	130	1900	4189	172	6300	13889	214	21200	46738
5	51.5	114	47	175	386	89	580	1279	131	1950	4299	173	6500	14330	215	21800	48061
6	53.0	117	48	180	397	90	600	1323	132	2000	4410	174	6700	14771	216	22400	49383
7	54.5	120	49	185	408	91	615	1356	133	2060	4542	175	6900	15212	217	23000	50706
8	56.0	123	50	190	419	92	630	1389	134	2120	4674	176	7100	15653	218	23600	52029
9	58.0	128	51	195	430	93	650	1433	135	2180	4806	177	7300	16094	219	24300	53572
10	60.0	132	52	200	441	94	670	1477	136	2240	4938	178	7500	16535	220	25000	55116
11	61.5	136	53	206	454	95	690	1521	137	2300	5071	179	7750	17086	221	25750	56769
12	63.0	139	54	212	467	96	710	1565	138	2360	5203	180	8000	17637	222	26500	58422
13	65.0	143	55	218	481	97	730	1609	139	2430	5357	181	8250	18188	223	27250	60076
14	67.0	148	56	224	494	98	750	1653	140	2500	5512	182	8500	18739	224	28000	61729
15	69.0	152	57	230	507	99	775	1709	141	2575	5677	183	8750	19290	225	29000	63934
16	71.0	157	58	236	520	100	800	1764	142	2650	5842	184	9000	19842	226	30000	66139
17	73.0	161	59	243	536	101	825	1819	143	2725	6008	185	9250	20393	227	30750	67792
18	75.0	165	60	250	551	102	850	1874	144	2800	6173	186	9500	20944	228	31500	69446
19	77.5	171	61	257	567	103	875	1929	145	2900	6393	187	9750	21495	229	32500	71650
20	80.0	176	62	265	584	104	900	1984	146	3000	6614	188	10000	22046	230	33500	73855
21	82.5	182	63	272	600	105	925	2039	147	3075	6779	189	10300	22708	231	34500	76059
22	85.0	187	64	280	617	106	950	2094	148	3150	6945	190	10600	23369	232	35500	78264
23	87.5	193	65	290	639	107	975	2150	149	3250	7165	191	10900	24030	233	36500	80469
24	90.0	198	66	300	661	108	1000	2205	150	3350	7385	192	11200	24692	234	37500	82673
25	92.5	204	67	307	677	109	1030	2271	151	3450	7606	193	11500	25353	235	38750	85429
26	95.0	209	68	315	694	110	1060	2337	152	3550	7826	194	11800	26015	236	40000	88185
27	97.0	214	69	325	717	111	1090	2403	153	3650	8047	195	12150	26786	237	41250	90941
28	100	220	70	335	739	112	1120	2469	154	3750	8267	196	12500	27558	238	42500	93696
29	103	227	71	345	761	113	1150	2535	155	3875	8543	197	12850	28329	239	43750	96452
30	106	234	72	355	783	114	1180	2601	156	4000	8818	198	13200	29101	240	45000	99208
31	109	240	73	365	805	115	1215	2679	157	4125	9094	199	13600	29983	241	46250	101964
32	112	247	74	375	827	116	1250	2756	158	4250	9370	200	14000	30865	242	47500	104719
33	115	254	75	387	853	117	1285	2833	159	4375	9645	201	14500	31967	243	48750	107475
34	118	260	76	400	882	118	1320	2910	160	4500	9921	202	15000	33069	244	50000	110231
35	121	267	77	412	908	119	1360	2998	161	4625	10196	203	15500	34172	245	51500	113538
36	125	276	78	425	937	120	1400	3086	162	4750	10472	204	16000	35274	246	53000	116845
37	128	282	79	437	963	121	1450	3197	163	4875	10748	205	16500	36376	247	54500	120152
38	132	291	80	450	992	122	1500	3307	164	5000	11023	206	17000	37479	248	56000	123459
39	136	300	81	462	1019	123	1550	3417	165	5150	11354	207	17500	38581	249	58000	127868
40	140	309	82	475	1047	124	1600	3527	166	5300	11684	208	18000	39683	250	60000	132277
41	145	320	83	487	1074	125	1650	3638	167	5450	12015	209	18500	40785	251	61500	135584
42	150	331	84	500	1102	126	1700	3748	168	5600	12346	210	19000	41888	252	63000	138891

Speed Symbol	A 1	A 2	A 3	A 4	A 5	A 6	A 7	A 8	B	C	D	E	F	G	J	K
Speed (km/h)	5	10	15	20	25	30	35	40	50	60	65	70	80	90	100	110
Speed (mph)	3	6	9	12	16	19	22	25	31	37	40	43	50	56	62	68

Speed Symbol	L	M	N	P	Q	R	S	T	U	H	V	VR	W	ZR	Y
Speed (km/h)	120	130	140	150	160	170	180	190	200	210	240	>210	270	>240	300
Speed (mph)	75	81	87	93	99	106	112	118	124	130	149	>130	168	>149	186

* lbs and mph as rounded values

Cyclic Service

The term "cyclic service" refers to situations where the tires fitted on vehicles such as industrial forklifts, port straddle carriers and reachstackers do not operate continuously at the load indicated by their load index or speed symbol. This applies, for example, to vehicle operating in two-way cycles: one way loaded with goods for transport, the other returning empty, and thus without a load. This means that the tires fitted on the vehicle do not drive continuously at the load and speed indicated by the load/speed index.

Impact of load on counter-balanced vehicles

On counter-balanced vehicles, the rear (steering wheels) is at maximum load when driving empty, while the front (drive wheels) is at maximum load when transporting goods.

Load capacity adjustments for industrial Pneumatic Tires by Vehicle Type

The maximum load capacity of the tire can be adjusted according to the speed of the vehicle. The amounts that can be adjusted are shown in the following table.

Application (1)	Counter-balanced vehicles		Rubber Tired Gantry Crane (5)	Straddle/Shuttle Carriers (5)	Ro-Ro Terminal Tractors (5)	Terminal Tractors and Trailers (5)	Automated Guided Vehicles (AGVs)	Sider Loader (Fork lift/Reachstacker)	Towbar Airport Tractor	Towbarless airport tractor	Small Ground Support Airport Tractor	Hot slag transporter	Heavy lift transport (5)	Other vehicles
	Load wheels	Steering wheels												
Cycle length (one way) (km)	1.6		0.6	2.5	2.5	2.5	1	1.6	7	7	2	3	10	* Please consult with tire manufacturer
Max. laden speed (km/h)	25.0		8.0	35.0	20.0	40.0	22.0	30.0	32.0	32.0	30.0	15.0	5.0	
Cyclic load	Yes		Yes	Yes	Yes	Yes	Yes	Yes	No	Yes	No	Yes	No	
Load variation table (%) vs - Speed (km/h) (2) (3)														
Static (4)	150	120	150	110	130	130	150	150	100	150	100	150	150	150
1	130	105	130	110	130	130	130	115	100	130	100	130	130	130
5	130	105	130	110	130	130	130	115	100	130	100	130	130	130
10	130	105	130	110	130	130	130	115	100	130	100	130	105	130
20	130	100	130	110	112.5	112.5	130	110	100	100	100	100	100	100
25	130	100	130	100	112.5	112.5	130	100	100	100	100	100	100	100
35	125	92.5	125	92.5	100	100	-	92.5	92.5	92.5	92.5	92.5	-	92.5
40	-	-	-	-	100	100	-	-	-	-	-	-	-	89
50	-	-	-	-	-	-	-	-	-	-	-	-	-	84

1 Cyclic service refers to applications where tires are not used continuously at the load indicated by their load index or the speed indicated by their speed symbol. It does not indicate the length of time a vehicle is in use, but rather that there is a variation in load and/or speed.

2 When operating at loads above the reference load, consult the tire manufacturer for approval. Interpolation is authorized for intermediate conditions according to the graphs on the following pages. No interpolation authorized between static and creep.

3 For tires up to 20 code diameter, the coefficient of 151 applies instead of 150.

4 It is recommended to never steer tires under static load condition.

5 Manned, remote controlled or automatic.

Load capacity adjustment for industrial Solid Tires mounted on Pneumatic Rims

The maximum load capacity of the tire can be adjusted according to the speed of the vehicle. The amounts that can be adjusted are shown in the following table.

Application	Counterbalanced Lift Truck Pick and Carry Crane rim code <20		Counterbalanced Lift Truck Pick and Carry Crane rim code >=20		Side Loader	Airport Baggage/ Container Trailer/ Cart Burden and Personnel Carrier Towing (Airport) Tractor	Port Container Trailer	Side Loader		Airport Baggage/ Container Trailer/ Cart Burden and Personnel Carrier Towing (Airport) Tractor	Port Container Trailer
	Load wheels	Steering wheels	Load wheels	Steering wheels	All positions	All positions	Allons	All positions rim code <20	All positions rim code <20	All positions rim code <20	All positions rim code <20
Cycle length (one way) (km)	<1.6		<1.6		<1.6	<2	<3	<2		<1.6	<0.6
Max. laden speed (km/h)	25 (for a distance exceeding 5 km within 1 hour, consult tire manufacturer)									15	10
Cyclic load (1)	Yes		Yes		Yes	No	Yes	Yes/no		Yes/no	Yes
Load Variation Table (%) versus Speed (km/h) (2) (3) (4)											
0	151	151	151	151	151	151	151	151	151	151	151
1	144	100	132	100	109	100	100	144	132	109	132
5	144	100	132	100	109	100	100	132	122 (6)	109	132
10	144	100	132	100	109	100	100	118	109 (6)	109	118
15	144	100	132	100	100	100	100	100	100	100	-
20	137	100	126 (5)	100	100	100	100	100	100	-	-
25	130	100	120 (5)	100	100	100	100	100	100	-	-

* Please consult with tire manufacturer.

- Cyclic service refers to applications where tires are not used continuously at the load indicated by their load index or the speed indicated by their speed symbol. It does not indicate the length of time a vehicle is in use, but rather that there is a variation in load and/or speed.
- When operating at loads above the reference load, please consult the tire manufacturer.
- No interpolation authorized between static and creep.
- The reference load is taken as the load carrying capacity of the steering wheels of an unloaded counter-balanced lift truck at maximum 25 km/h.
- For tire size 355/50-20, a coefficient of 130 applies at 20 and 25 km/h.
- For tire size 355/50-20, a coefficient of 132 applies at 5 km/h and a coefficient of 118 applies at 10 km/h.



Continental Material Handling and Port Operations Tires – Construction Overview

Continental manufactures five main tire construction types for Material Handling and Port Operations tires: Industrial radial, X-ply, V-ply, solid tires for pneumatic type rims, and solid tires for press on rims.

The following pages provide an overview and detailed anatomy of the different constructions and, in the case of port operations, the advantages and disadvantages of radial and V-ply tires.

Solid Tire Construction

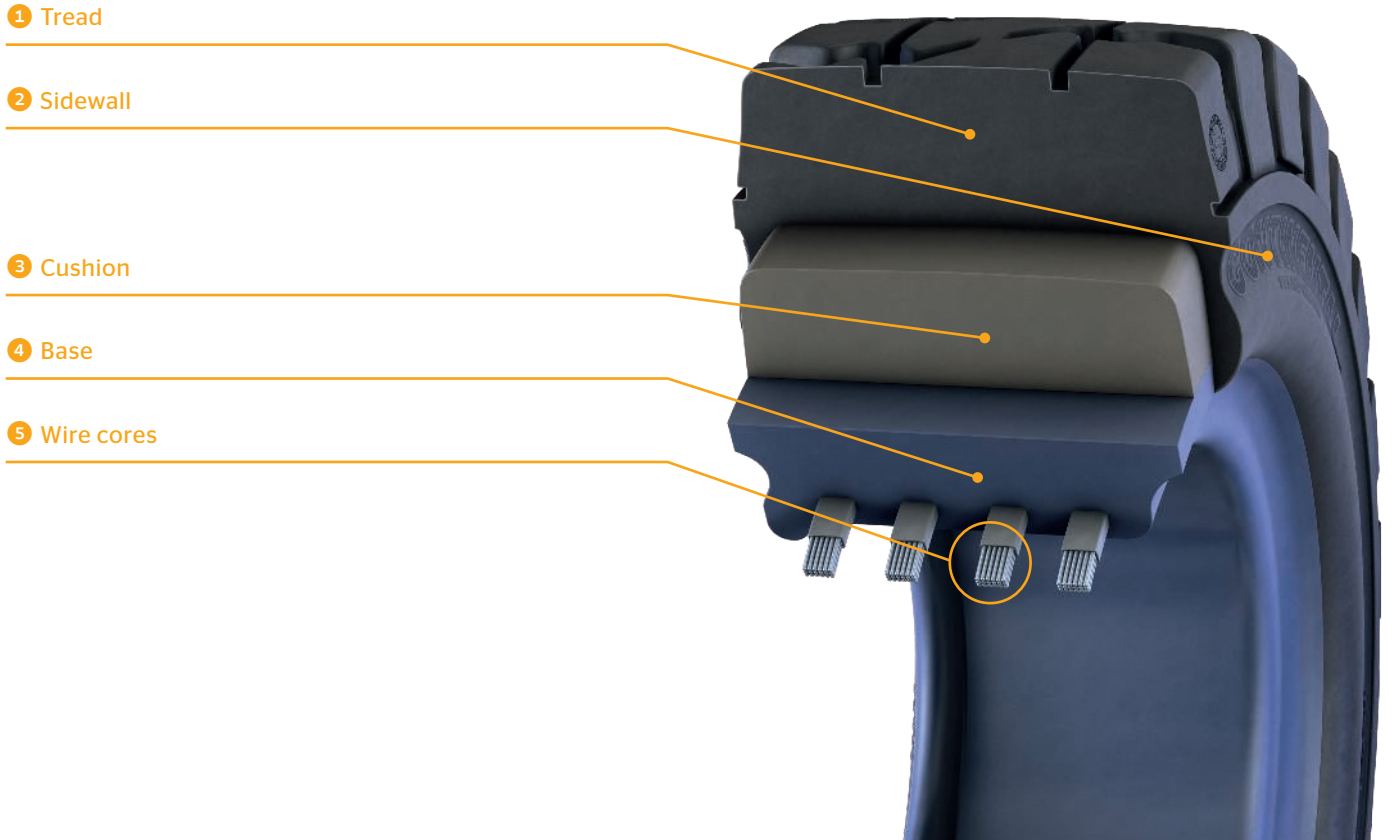

Depicts tire construction for an example in tire size of 180/70-8 SC20+.

- | | |
|---------------------|--|
| 1 Tread | The tread is made of a highly cut and wear-resistant compound, providing high tilting stability and a long service life. |
| 2 Sidewall | The sidewall consists of a highly cut and wear-resistant compound that protects the cushion. |
| 3 Cushion | The cushion compound provide extremely low damping properties. This leads to low rolling resistance and, as a result, lower heat generation. |
| 4 Base | The base with embedded wire cores (bead strings) ensures optimal rim fitment. |
| 5 Wire cores | Rectangular wire cores provide even pressure distribution and excellent rim fitment. |

Super Elastics are made to fit on industrial pneumatic tire rims. The multi-layer construction offers a long service life and a very low rolling resistance, which reduces energy consumption and generates less heat in the tire.

Steel Wire Reinforcement Construction

① + ② Cut and wear-resistant tread and sidewall

③ Low damping cushion
(in Robust version)

④ Steel wire cores

⑤ Base

Cylindrical base (Z)

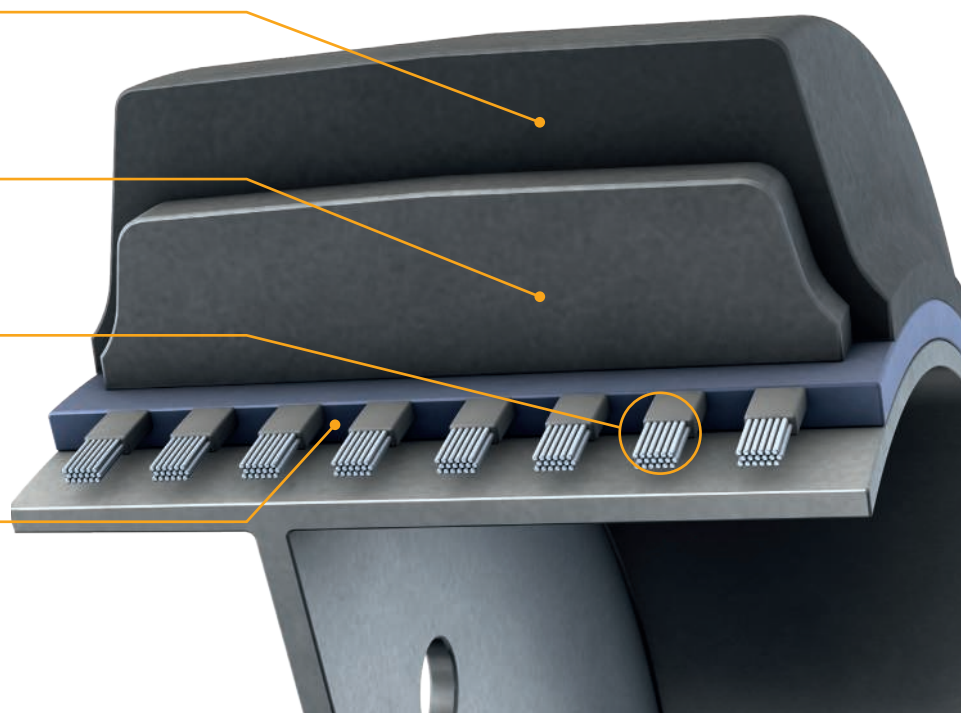

Depicts tire construction in an example in tire size of 21 X 9 X 15

① Tread	The tread is made of a highly cut and wear-resistant compound, providing high tilting stability and a long service life.
② Sidewall	The sidewall consists of a highly cut and wear-resistant compound that protects the cushion.
③ Cushion “A-Robust” only	The cushion compound provide extremely low damping properties. This leads to low rolling resistance and, as a result, lower heat generation.
④ Wire cores	Rectangular wire cores provide even pressure distribution and excellent rim fitment.
⑤ Base	The base with embedded wire cores (bead strings) ensures optimal rim fitment.

Press-on Bands are made to fit on industrial press on wheels/rims. The multi-layer construction offers a long service life, due to low rolling resistance and the resulting lower heat generation.

Steel Base Construction

① + ② Cut and wear-resistant tread and sidewall

③ Low damping cushion
(in Robust version)

④ Steel band

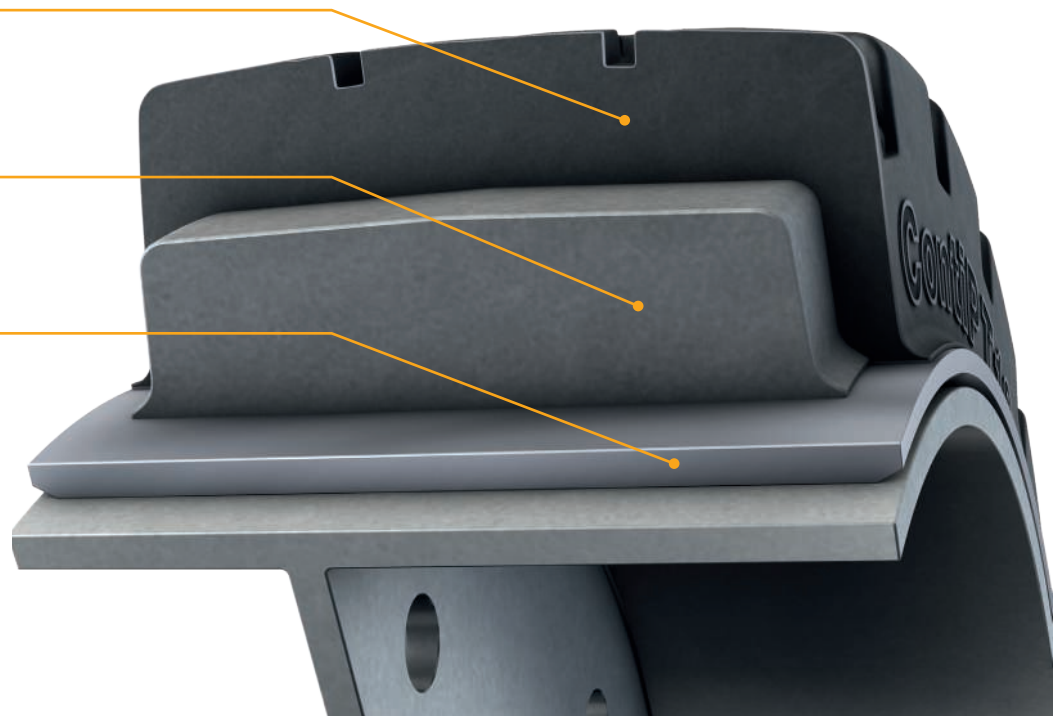

Depicts tire construction in an example in tire size of 21 X 7 X 15

- | | |
|----------------------------------|---|
| ① Tread | The tread is made of a highly cut and wear-resistant compound, providing high tilting stability and a long service life. |
| ② Sidewall | The sidewall consists of a highly cut and wear-resistant compound that protects the cushion. |
| ③ Cushion “A-Robust” only | The cushion compound provide extremely low damping. This leads to low rolling resistance and, as a result, lower heat generation. |
| ④ Steel Band | Steel band provides even pressure distribution and excellent rim fitment. |

Press-on Bands are made to fit on industrial press on wheels/rims. The multi-layer construction offers a long service life, due to low rolling resistance and the resulting lower heat generation.

Radial Tire Construction

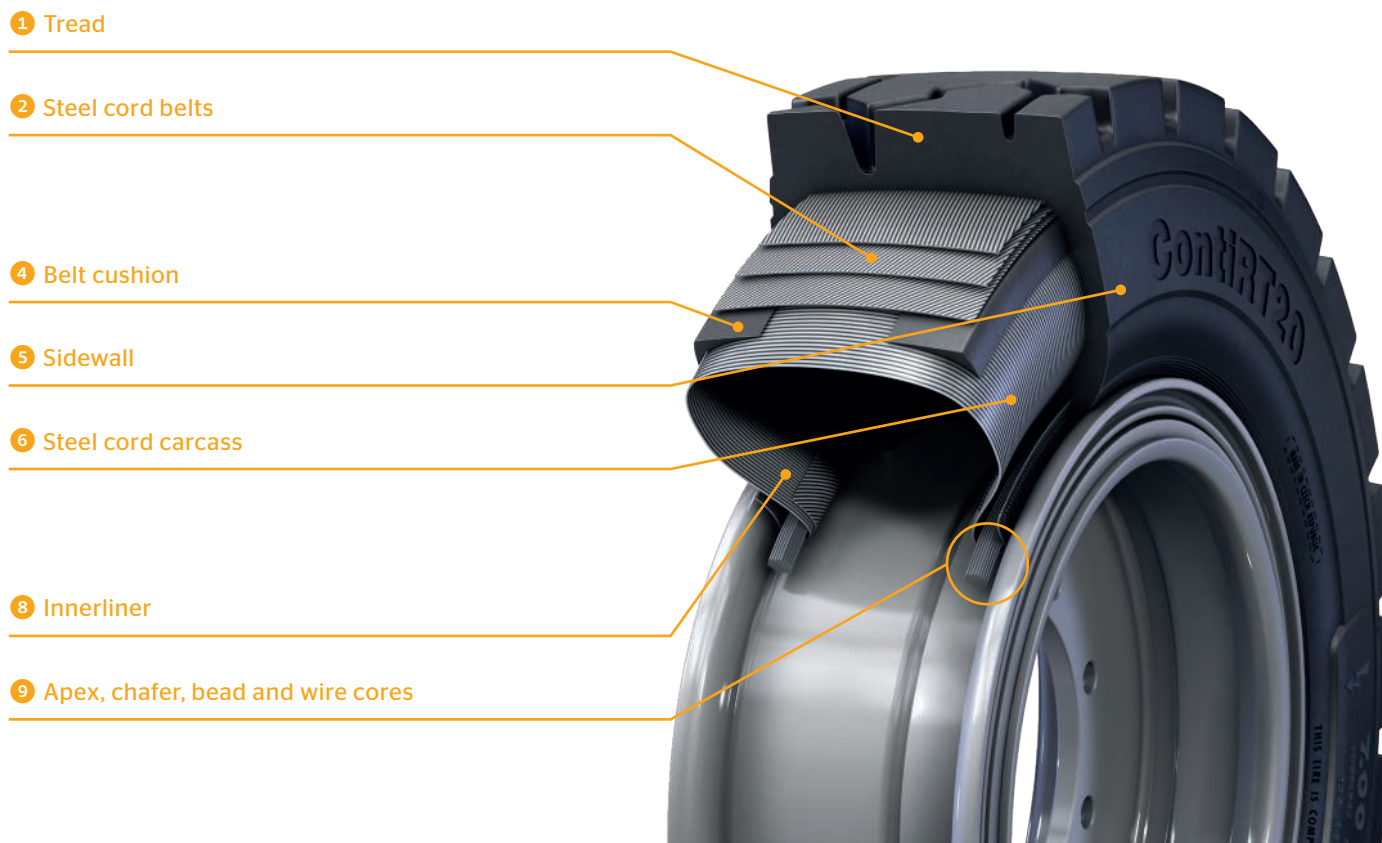

Depicts tire construction in an example in tire size of 7.00 R12 ContiRT20

1 Tread	This wear-resistant rubber protects the carcass and belt against fractures and impact.
2 Steel cord belts	The belts are layers of steel cord located between the tread and the body ply. The belts increase the rigidity of the tread, increasing the tire's resistance to cuts. They also transmit the torque to the radial ply and restrict tire expansion.
3 Breakers	Breakers are placed between the carcass and tread to protect the carcass of a cross-ply (or bias) tire.
4 Belt cushion	This component reduces heat generation.
5 Sidewall	The sidewall is a protective rubber coating on the outer side of the tire. It is designed to resist cutting and cracking.
6 Steel, cord carcass	The carcass is designed to help maintain air pressure and absorb shocks. It consists of steel-ply cords and has high strength in order to ensure structural durability combined with high flexibility, excellent damping and rolling resistance.

In a radial construction, the steel carcass material runs directly from bead to bead (radial) and the tread is stabilized by steel belts; the sidewall and tread function independently of each other. The shocks absorbed by the sidewall are not transferred into the tread. There is a minimized width deformation of the contact patch. A radial tire has a carcass of one or more layers of fibers or steel at approximately 90 degrees, and a belt made of crosswise-layered fibers or steel.

Cross-ply Tires Construction (X-ply and V.ply)

1 Tread

3 Breakers

5 Sidewall

7 Textile carcass

8 Innerliner

9 Apex, chafer, bead and wire cores



Depicts tire construction in an example in tire size of 18.00-25 TerminalMaster V.ply

1 Textile carcass	The carcass is designed to help maintain air pressure and absorb shocks. It consists of layers of nylon plies and has high strength in order to ensure structural durability combined with high flexibility.
2 Innerliner	The innerliner is an integral part of all tubeless pneumatic tires. It covers the inside of the tire from bead to bead and ensures the air-tightness of the tire.
3 Apex	Due to its hardness, the apex stabilizes the bead area.
Chafer	The chafer protects the bead and body from chafing (wear caused by rubbing) where the tire is in contact with the rim. It offers high resistance against mechanical stress (mounting process).
Bead	Considered the foundation of the tire, this “anchors” the bead on the rim.
Wire cores	Wire cores have high strength in order to ensure the structural durability to keep the tire on the rim. The ends of the cord plies are wrapped around them.

In a cross-ply construction, the carcass consists of multiple layers of fabric, running diagonally from one bead to the other. The tread and sidewall are coupled to form a single unit. All shock-absorbing movements of the sidewall are transferred into the tread, meaning that the contact patch width varies in size and shape depending the ground surface. The multiple carcass layers result in a highly robust sidewall construction.

Continental V.ply Technology for Material Handling and Port Operations Tires

Radial

- › Enhanced mileage
- › Good driving comfort
- › Increased traction



Cross-ply

- › Good vehicle stability
- › Good self-cleaning on muddy ground
- › Damage-resistant sidewall



As this overview shows the perfect Port Operations tire would have a hybrid radial/cross-ply construction offering the best of both worlds. Cross-ply provides several essential features for a Port Operations tire, such as good stability when lifting and stacking containers. This is due to the cross-ply design. However, on firm grounds and paved surfaces, cross-ply may display some disadvantages compared to radial tires. Here, its flexible belt leads to increased rolling resistance, and therefore higher heat buildup over longer distances as well as a higher wear rate. Moreover, the tire flexing provides reduced driving comfort. Therefore, cross-ply is not the best choice when it comes to certain applications when driving higher distances over the course of the day and, by definition, also higher average speeds.

A truly versatile Port Operations tire would offer high stability with a low rolling resistance. How can these two conflicting aims be reconciled? Here at Continental, we have found a way to merge these core requirements into a single technology. We call it V.ply, and it narrows the gap by introducing three new and innovative steps to the manufacturing process:

- › Improving the carcass ply
- › Reducing rubber
- › Optimizing the curing process.

In short, V.ply is designed to significantly reduce rolling resistance while maintaining the distinctive high stability of cross-ply Material Handling and Port Operations tires. This can bridge the gap to radial tires up to a certain limit, and provide additional flexibility when occasionally driving longer distances, in addition to the normal stacking requirements, and all without giving up the high stability.

Nevertheless, depending on the specific application in question, a radial tire may be more suitable than a V.ply tire, especially where longer driving distances and higher speeds are common. Here, a radial tire with its low heat generation, and higher mileage potential is the tire of choice.

With our Continental V.ply and radial ranges we have the perfect solution whatever your requirements.

Improved carcass

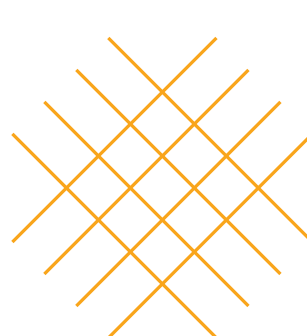

Cross-ply angle



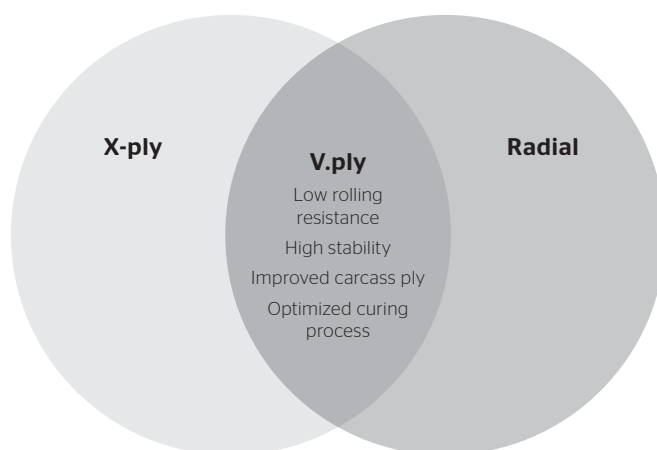

V.ply angle



Performance Matrix - Port Operations Tires - Radial vs. V.ply

There are advantages and disadvantages to each type of tire construction. A brief overview and explanation of the main items is provided in the table below; this is intended to help you to choose the right tire for the vehicle application in question.

Criteria	Radial	V.ply	Explanation
			
Tread life	●		Less movement between tire tread and ground surface compared to V.ply tires results in less abrasion and therefore better tire life overall.
Heat generation	●		Less inner friction between the tire components of a radial tire compared to a V.ply tire (one radial steel carcass ply vs. several nylon plies) reduces transformation of kinetic energy into thermal energy.
Tread impact resistance	●		Several steel belts in the tread area of a radial tire in combination with the more flexible carcass construction offer better tread impact resistance.
Sidewall robustness		●	Due to multiple carcass layers, V.ply tires have in general thicker sidewalls compared to radial tires.
Traction	●		As a general rule, the radial construction results a higher ground contact area, allowing for better traction force transmission.
Stability		●	The thicker sidewalls of V.ply tires lower deflection in radial and axial direction, generally resulting in more stability.
Repairability		●	Thicker casing of V.ply tires tend to have better tolerance for cut / impact repairs in the tread as well as in the sidewall area.
Fuel economy	●		In general, radial tires have a lower rolling resistance than V.ply tires (primarily due to the factors listed above in 'Heat resistance').
Rim component life		●	Most V.ply tires have a wider bead than radial tires and therefore more contact area to the rim which results in less stress for the rim components as forces are distributed to a larger area.
PU filling		●	V.ply tires don't tend to fail with the 'zipper' sidewall breaks, which is typical for radial tires, V.ply tires tend to work better with PU fillings, a characteristic which is partly due to their multiple crossed carcass layers.

● Generally offers better performance for this criterion



Continental Material Handling and Port Operations Tire Portfolio Overview

Continental Material Handling and Port Operation tires are developed for an increasingly diverse range of vehicles operating in a wide variety of applications.

Our tires are used in a multitude of different industries, including large multinational production companies, global logistics giants, busy international hub airports, and a large number of small-to-medium-sized enterprises in a wide range of sectors, from manufacturing, food and beverages, warehousing, and retail, to the fast-growing e-commerce field.

Our Port Operations tires are fitted to large container-handling mobile cranes operating in port terminals and depots that help to drive the global supply chain around the globe. They are also fitted in inland river and intermodal road/rail terminals as well as in special heavy industry applications where the very heavy loads demand an OTR-type tire.

Whatever the vehicle, one thing they all have in common is they rely on high performing tires to move freight, such as raw materials and finished goods.

Continental's wide range of specialist products is built to last so this can be done efficiently and effectively.

The following pages provide an overview of the Continental Material Handling and Port Operations tire portfolio and an insight to the features and benefits of each model.

Continental Super Elastic Tires



SC20

- › The tire is suited for highest demands and applications in 3-shift operations
- › The overall performance and energy efficiency make the SC20+ a tire for indoor and outdoor usage on any surface
- › Continental Plus Compound

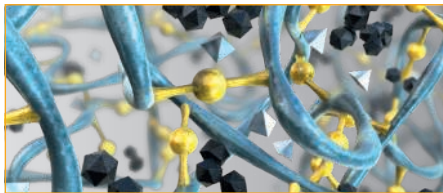

Exceptional mileage with low rolling resistance

Up to 20% higher mileage* with low rolling resistance

*Compared to SC20+



Excellent traction

Proven and tested profile with large, individual profile blocks and pronounced linear grooves delivering excellent traction



High durability

Optimized compound thanks to short- chained sulfur components with advanced silica portion for the highest level of resistance against cracking



SC18 (*)



- › Wear-resistant tread compound
- › Anti-chip and chunk-damage-resistant compound
- › Low rolling resistance for low energy consumption and low heat buildup for high endurance
- › Outstanding mileage performance

(*) For Americas/APAC sales region

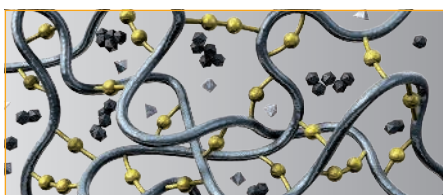

Heat-Resistant Compound

High mileage

Tire wears slowly, smoothly and evenly



Robust Sidewall

High durability

Improved abrasion behavior

Cut and chunk resistance



Rectangular Bead Technology

Great surface contact

High comfort level thanks to excellent rim fit

Continental Super Elastic Tires



CS20

- › Wide shoulder rib for minimum vibrations to ensure overall comfort
- › Perfect for hard and smooth indoor surfaces in 3-shift operations
- › Outstanding endurance thanks to the Continental Plus Compound



Maximum steering precision

The closed shoulder design allows for a fast and direct steering response



Excellent cornering stability

A wide shoulder rib ensures continuous contact between the tire and ground surface, preventing vibration and noise development for a smooth drive

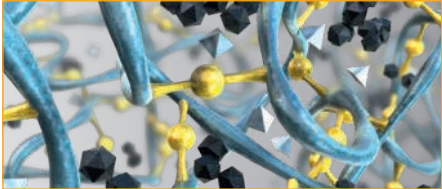

Exceptional mileage

Up to 20% more mileage* on hard abrasive ground/floor surfaces and increased damage resistance

*Compared to predecessor



SH12

- › Specialized slick tire
- › Primarily for indoor use on severe and smooth surfaces
- › Continental Plus Compound offers exceptional mileage and great protection from damage



Excellent driving comfort

Low vibrations thanks to the slick design enable an exceptionally smooth performance



Very good damage resistance

The slick design leads to an increased damage resistance and excellent reliability due to a lower number of tread edges compared to the profile pattern

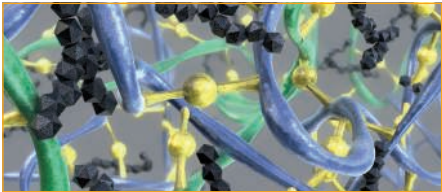

Optimized mileage

Up to 20% higher mileage* on severe, abrasive surfaces

*Compared to predecessor

Continental Super Elastic Tires



CSEasy

- › Adapter system for easy installation without using industrial fitting press
- › Low wear abrasion for excellent durability
- › Reduced rolling resistance
- › Outstanding energy efficiency
- › Vehicle downtimes reduced to a minimum



ContiPT18



- › High tilting stability
- › Very high load capacity
- › Low rolling resistance
- › Robust construction
- › Exceptional traction



MH20



- › Excellent stability
- › Minimal vibration
- › Maximum dry traction
- › Low rolling resistance
- › Long service life



MC20



- › Excellent traction
- › Low rolling resistance
- › Reduced fuel consumption
- › High carrying capacity
- › Sturdy design



Technical Data Super Elastic Tires

Size range, specifications and tire load capacities

Size	Tire			Rim	Tire dimensions [mm]				
	Pattern	LI	SSY		Article approximate data				
					Usable Tread height	Width	Outer dia.	Static ¹⁾ rad.	Rolling ²⁾ circ.
4.00 - 4/2.50	SC10	77	A5	2.50 C-4	23	90	301	143	965
140/55 - 6/4.50	SC15	101	A5	4.50 E-6	25	142	310	145	1013
4.00 - 8/3.00	CS20	97	A5	3.00 D-8	38	103	399	289	1261
	SC20	97	A5	3.00 D-8	34	105	402	191	1265
15 X 4 1/2 - 8/3.00	SC11	100	A5	3.00 D-8	27	110	376	179	1205

1) At reference load

2) Other vehicles: e.g. trailers, self-propelled machines, tractors, mobile cranes, straddle carriers, forklifts without counterweight, side-loading forklifts etc.

3) For tires used on straddle carriers and straddle fork lifts with max. speed of 25 km/h the load capacity of steered wheels have to be used.

Application	Tire load capacity [kg]								Size
	Lift Truck		Side Loader	Airport	Port Trailer	Other ² Vehicles	Multi Directional	Gantry Crane	
	Load Wheel	Steer ³ Wheel							
Cycle Length (one way) km	< 1.6		< 1.6	< 2	< 3	< 2	< 1.6	< 0.6	
Max. laden speed (km/h)	25 (for distance exceeding 6 km within 1h, consult tire manufacturer)						15	10	
Cyclic Load	Yes		Yes	No	Yes	Yes/No	Yes/No	Yes	
Speed	Load[kg]								
0	620	620	620	620	620	620	620	620	4.00 - 4/2.50
1	590	410	445	410	410	590	445	540	
5	590	410	445	410	410	540	445	540	
10	590	410	445	410	410	485	445	485	
15	590	410	410	410	410	410	410	-	
20	560	410	410	410	410	410	-	-	
25	535	410	410	410	410	410	-	-	
0	1245	1245	1245	1245	1245	1245	1245	1245	140/55 - 6/4.50
1	1190	825	900	825	825	1190	900	1090	
5	1190	825	900	825	825	1090	900	1090	
10	1190	825	900	825	825	975	900	975	
15	1190	825	825	825	825	825	825	-	
20	1130	825	825	825	825	825	-	-	
25	1075	825	825	825	825	825	-	-	
0	1100	1100	1100	1100	1100	1100	1100	1100	4.00 - 8/3.00
1	1050	730	795	730	730	1050	795	965	
5	1050	730	795	730	730	965	795	965	
10	1050	730	795	730	730	860	795	860	
15	1050	730	730	730	730	730	730	-	
20	1000	730	730	730	730	730	-	-	
25	950	730	730	730	730	730	-	-	
0	1210	1210	1210	1210	1210	1210	1210	1210	15 X 4 1/2 - 8/3.00
1	1150	800	870	800	800	1150	870	1055	
5	1150	800	870	800	800	1055	870	1055	
10	1150	800	870	800	800	945	870	945	
15	1150	800	800	800	800	800	800	-	
20	1095	800	800	800	800	800	-	-	
25	1040	800	800	800	800	800	-	-	

Technical Data Super Elastic Tires

Size range, specifications and tire load capacities

Size	Tire			Rim	Tire dimensions [mm]				
	Pattern	LI	SSY		Article approximate data				
					Usable Tread height	Width	Outer dia.	Static ¹⁾ rad.	Rolling ²⁾ circ.
125/75 - 8/3.00	CS20	100	A5	3.00 D-8	30	119	377	179	1184
	CSEASY	100	A5	3.00 D-8	31	121	377	181	1205
	SC18	100	A5	3.00 D-8	27	121	377	178	1208
	SC20	100	A5	3.00 D-8	31	121	377	179	1210
	SH12	100	A5	3.00 D-8	27	121	377	179	1208
5.00 - 8/3.00	CSEASY	111	A5	3.00 D-8	43	124	459	216	1437
	SC18	111	A5	3.00 D-8	39	126	459	214	1468
	SC20	111	A5	3.00 D-8	43	124	459	216	1429
150/75 - 8/4.33	CS20	113	A5	4.33 R-8	35	154	417	198	1307
	CSEASY	113	A5	4.33 R-8	36	156	417	200	1330
	SC15	113	A5	4.33 R-8	32	156	417	199	1334
	SC18	113	A5	4.33 R-8	32	156	417	199	1334
	SC20	113	A5	4.33 R-8	36	156	417	197	1340
180/70 - 8/4.33	CS20	125	A5	4.33 R-8	41	156	453	211	1431
	CSEASY	125	A5	4.33 R-8	46	156	454	214	1450
	CSEasy SH12	125	A5	4.33 R-8	30	156	454	209	1423
	SC15	125	A5	4.33 R-8	38	156	454	212	1452
	SC18	125	A5	4.33 R-8	38	156	454	212	1452
	SC20	125	A5	4.33 R-8	46	156	454	211	1432
	SH12	125	A5	4.33 R-8	30	156	454	208	1429

1) At reference load

2) Other vehicles: e.g. trailers, self-propelled machines, tractors, mobile cranes, straddle carriers, forklifts without counterweight, side-loading forklifts etc.

3) For tires used on straddle carriers and straddle fork lifts with max. speed of 25 km/h the load capacity of steered wheels have to be used.

Application	Tire load capacity [kg]								Size
	Lift Truck		Side Loader	Airport	Port Trailer	Other ² Vehicles	Multi Directional	Gantry Crane	
	Load Wheel	Steer ³ Wheel							
Cycle Length (one way) km	< 1.6		< 1.6	< 2	< 3	< 2	< 1.6	< 0.6	
Max. laden speed (km/h)	25 (for distance exceeding 6 km within 1h, consult tire manufacturer)						15	10	
Cyclic Load	Yes		Yes	No	Yes	Yes/No	Yes/No	Yes	
Speed	Load[kg]								
0	1210	1210	1210	1210	1210	1210	1210	1210	125/75 - 8/3.00
1	1150	800	870	800	800	1150	870	1055	
5	1150	800	870	800	800	1055	870	1055	
10	1150	800	870	800	800	945	870	945	
15	1150	800	800	800	800	800	800	-	
20	1095	800	800	800	800	800	-	-	
25	1040	800	800	800	800	800	-	-	
0	1645	1645	1645	1645	1645	1645	1645	1645	5.00 - 8/3.00
1	1570	1090	1190	1090	1090	1570	1190	1440	
5	1570	1090	1190	1090	1090	1440	1190	1440	
10	1570	1090	1190	1090	1090	1285	1190	1285	
15	1570	1090	1090	1090	1090	1090	1090	-	
20	1495	1090	1090	1090	1090	1090	-	-	
25	1415	1090	1090	1090	1090	1090	-	-	
0	1735	1735	1735	1735	1735	1735	1735	1735	150/75 - 8/4.33
1	1655	1150	1255	1150	1150	1655	1255	1520	
5	1655	1150	1255	1150	1150	1520	1255	1520	
10	1655	1150	1255	1150	1150	1355	1255	1355	
15	1655	1150	1150	1150	1150	1150	1150	-	
20	1575	1150	1150	1150	1150	1150	-	-	
25	1495	1150	1150	1150	1150	1150	-	-	
0	2490	2490	2490	2490	2490	2490	2490	2490	180/70 - 8/4.33
1	2375	1650	1800	1650	1650	2375	1800	2180	
5	2375	1650	1800	1650	1650	2180	1800	2180	
10	2375	1650	1800	1650	1650	1945	1800	1945	
15	2375	1650	1650	1650	1650	1650	1650	-	
20	2260	1650	1650	1650	1650	1650	-	-	
25	2145	1650	1650	1650	1650	1650	-	-	

Technical Data Super Elastic Tires

Size range, specifications and tire load capacities

Size	Tire			Rim	Tire dimensions [mm]				
	Pattern	LI	SSY		Article approximate data				
					Usable Tread height	Width	Outer dia.	Static ¹⁾ rad.	Rolling ²⁾ circ.
140/55 - 9/4.00	CS20	104	A5	4.00 E-9	28	129	375	180	1197
	SC11	104	A5	4.00 E-9	31	131	377	180	1218
	SC15	104	A5	4.00 E-9	31	131	377	180	1210
	SC18	104	A5	4.00 E-9	31	131	377	181	1207
	SC20	104	A5	4.00 E-9	31	131	377	180	1218
6.00 - 9/4.00	CS20	121	A5	4.00 E-9	48	140	527	247	1658
	CSEASY	121	A5	4.00 E-9	50	140	529	249	1665
	SC11	121	A5	4.00 E-9	32	138	521	243	1650
	SC18	121	A5	4.00 E-9	46	143	529	247	1695
	SC20	121	A5	4.00 E-9	50	140	529	248	1653
200/75 - 9/6.00	CSEASY	134	A5	6.00 E-9	52	181	524	246	1670
	SC18	134	A5	6.00 E-9	45	181	524	245	1647
	SC20	134	A5	6.00 E-9	52	181	524	244	1650
6.50 - 10/5.00	CS20	128	A5	5.00 F-10	55	160	574	270	1815
	CSEASY	128	A5	5.00 F-10	55	162	576	270	1840
	SC15	128	A5	5.00 F-10	50	162	576	270	1846
	SC18	128	A5	5.00 F-10	50	162	576	270	1846
	SC20	128	A5	5.00 F-10	55	162	576	270	1808

1) At reference load

2) Other vehicles: e.g. trailers, self-propelled machines, tractors, mobile cranes, straddle carriers, forklifts without counterweight, side-loading forklifts etc.

3) For tires used on straddle carriers and straddle fork lifts with max. speed of 25 km/h the load capacity of steered wheels have to be used.

Application	Tire load capacity [kg]								Size
	Lift Truck		Side Loader	Airport	Port Trailer	Other ² Vehicles	Multi Directional	Gantry Crane	
	Load Wheel	Steer ³ Wheel							
Cycle Length (one way) km	< 1.6		< 1.6	< 2	< 3	< 2	< 1.6	< 0.6	
Max. laden speed (km/h)	25 (for distance exceeding 6 km within 1h, consult tire manufacturer)						15	10	
Cyclic Load	Yes		Yes	No	Yes	Yes/No	Yes/No	Yes	
Speed	Load[kg]								
0	1360	1360	1360	1360	1360	1360	1360	1360	140/55 - 9/4.00
1	1295	900	980	900	900	1295	980	1190	
5	1295	900	980	900	900	1190	980	1190	
10	1295	900	980	900	900	1060	980	1060	
15	1295	900	900	900	900	900	900	-	
20	1235	900	900	900	900	900	-	-	
25	1170	900	900	900	900	900	-	-	
0	2190	2190	2190	2190	2190	2190	2190	2190	6.00 - 9/4.00
1	2090	1450	1580	1450	1450	2090	1580	1915	
5	2090	1450	1580	1450	1450	1915	1580	1915	
10	2090	1450	1580	1450	1450	1710	1580	1710	
15	2090	1450	1450	1450	1450	1450	1450	-	
20	1985	1450	1450	1450	1450	1450	-	-	
25	1885	1450	1450	1450	1450	1450	-	-	
0	3200	3200	3200	3200	3200	3200	3200	3200	200/75 - 9/6.00
1	3055	2120	2310	2120	2120	3055	2310	2800	
5	3055	2120	2310	2120	2120	2800	2310	2800	
10	3055	2120	2310	2120	2120	2500	2310	2500	
15	3055	2120	2120	2120	2120	2120	2120	-	
20	2905	2120	2120	2120	2120	2120	-	-	
25	2755	2120	2120	2120	2120	2120	-	-	
0	2720	2720	2720	2720	2720	2720	2720	2720	6.50 - 10/5.00
1	2590	1800	1960	1800	1800	2590	1960	2375	
5	2590	1800	1960	1800	1800	2375	1960	2375	
10	2590	1800	1960	1800	1800	2125	1960	2125	
15	2590	1800	1800	1800	1800	1800	1800	-	
20	2465	1800	1800	1800	1800	1800	-	-	
25	2340	1800	1800	1800	1800	1800	-	-	

Technical Data Super Elastic Tires

Size range, specifications and tire load capacities

Size	Tire			Rim	Tire dimensions [mm]				
	Pattern	LI	SSY		Article approximate data				
					Usable Tread height	Width	Outer dia.	Static ¹⁾ rad.	Rolling ²⁾ circ.
180/60 - 10/5.00	CS20	129	A5	5.00 F-10	34	158	452	212	1442
	CSEASY	129	A5	5.00 F-10	32	160	456	218	1495
	SC15	129	A5	5.00 F-10	33	160	454	214	1467
	SC20	129	A5	5.00 F-10	36	160	454	213	1450
	SH12	129	A5	5.00 F-10	28	160	454	214	1449
200/50 - 10/6.50	CS20	130	A5	6.50 F-10	38	196	451	213	1447
	CSEASY	130	A5	6.50 F-10	31	190	457	220	1505
	SC15	130	A5	6.50 F-10	35	196	452	214	1456
	SC18	130	A5	6.50 F-10	35	196	452	213	1456
	SC20	130	A5	6.50 F-10	38	196	452	213	1450
	SH12	130	A5	6.50 F-10	30	195	450	213	1442
225/75 - 10/6.50	CS20	142	A5	6.50 F-10	51	195	577	268	1824
	CSEASY	142	A5	6.50 F-10	55	193	583	272	1865
	SC18	142	A5	6.50 F-10	50	193	583	269	1868
	SC20	142	A5	6.50 F-10	55	193	583	272	1837
	SH12 RFI	142	A5	6.50 F-10	52	195	577	266	1821
7.00 - 12/5.00	CS20	136	A5	5.00 S-12	57	171	655	307	2073
	CSEASY	136	A5	5.00 S-12	60	173	657	310	2080
	SC15	136	A5	5.00 S-12	54	173	657	308	2105
	SC18	136	A5	5.00 S-12	54	173	657	308	2105
	SC20	136	A5	5.00 S-12	60	173	657	309	2052

1) At reference load

2) Other vehicles: e.g. trailers, self-propelled machines, tractors, mobile cranes, straddle carriers, forklifts without counterweight, side-loading forklifts etc.

3) For tires used on straddle carriers and straddle fork lifts with max. speed of 25 km/h the load capacity of steered wheels have to be used.

Application	Tire load capacity [kg]								Size
	Lift Truck		Side Loader	Airport	Port Trailer	Other ² Vehicles	Multi Directional	Gantry Crane	
	Load Wheel	Steer ³ Wheel							
Cycle Length (one way) km	< 1.6		< 1.6	< 2	< 3	< 2	< 1.6	< 0.6	
Max. laden speed (km/h)	25 (for distance exceeding 6 km within 1h, consult tire manufacturer)						15	10	
Cyclic Load	Yes		Yes	No	Yes	Yes/No	Yes/No	Yes	
Speed	Load[kg]								
0	2795	2795	2795	2795	2795	2795	2795	2795	180/60 - 10/5.00
1	2665	1850	2015	1850	1850	2665	2015	2440	
5	2665	1850	2015	1850	1850	2440	2015	2440	
10	2665	1850	2015	1850	1850	2185	2015	2185	
15	2665	1850	1850	1850	1850	1850	1850	-	
20	2535	1850	1850	1850	1850	1850	-	-	
25	2405	1850	1850	1850	1850	1850	-	-	
0	2870	2870	2870	2870	2870	2870	2870	2870	200/50 - 10/6.50
1	2735	1900	2070	1900	1900	2735	2070	2510	
5	2735	1900	2070	1900	1900	2510	2070	2510	
10	2735	1900	2070	1900	1900	2240	2070	2240	
15	2735	1900	1900	1900	1900	1900	1900	-	
20	2605	1900	1900	1900	1900	1900	-	-	
25	2470	1900	1900	1900	1900	1900	-	-	
0	4000	4000	4000	4000	4000	4000	4000	4000	225/75 - 10/6.50
1	3815	2650	2890	2650	2650	3815	2890	3500	
5	3815	2650	2890	2650	2650	3500	2890	3500	
10	3815	2650	2890	2650	2650	3125	2890	3125	
15	3815	2650	2650	2650	2650	2650	2650	-	
20	3630	2650	2650	2650	2650	2650	-	-	
25	3445	2650	2650	2650	2650	2650	-	-	
0	3380	3380	3380	3380	3380	3380	3380	3380	7.00 - 12/5.00
1	3225	2240	2440	2240	2240	3225	2440	2955	
5	3225	2240	2440	2240	2240	2955	2440	2955	
10	3225	2240	2440	2240	2240	2645	2440	2645	
15	3225	2240	2240	2240	2240	2240	2240	-	
20	3070	2240	2240	2240	2240	2240	-	-	
25	2910	2240	2240	2240	2240	2240	-	-	

Technical Data Super Elastic Tires

Size range, specifications and tire load capacities

Size	Tire			Rim	Tire dimensions [mm]				
	Pattern	LI	SSY		Article approximate data				
					Usable Tread height	Width	Outer dia.	Static ¹⁾ rad.	Rolling ²⁾ circ.
250/60 - 12/8.00	CS20	145	A5	8.00 G-12	41	232	571	270	1829
	CSEASY	145	A5	8.00 G-12	43	234	574	277	1903
	SC18	145	A5	8.00 G-12	38	234	574	271	1839
	SC20	145	A5	8.00 G-12	43	234	574	270	1830
250/75 - 12/8.00	CS20	146	A5	8.00 G-12	61	231	674	316	2123
	CSEASY	146	A5	8.00 G-12	63	233	676	318	2160
	SC18	146	A5	8.00 G-12	56	233	676	316	2166
	SC20	146	A5	8.00 G-12	63	233	676	318	2127
	SH12	146	A5	8.00 G-12	55	233	673	317	2141
315/45 - 12/10.00	CS20	151	A5	10.00 G-12	43	284	572	270	1840
	SC18	151	A5	-	39	285	574	272	1863
	SC20	151	A5	10.00 G-12	43	285	574	270	1863
23 X 5/3.75	SC20	113	A5	3.75 P-13	40	138	616	295	1921

1) At reference load

2) Other vehicles: e.g. trailers, self-propelled machines, tractors, mobile cranes, straddle carriers, forklifts without counterweight, side-loading forklifts etc.

3) For tires used on straddle carriers and straddle fork lifts with max. speed of 25 km/h the load capacity of steered wheels have to be used.

Application	Tire load capacity [kg]								Size
	Lift Truck		Side Loader	Airport	Port Trailer	Other ² Vehicles	Multi Directional	Gantry Crane	
	Load Wheel	Steer ³ Wheel							
Cycle Length (one way) km	< 1.6		< 1.6	< 2	< 3	< 2	< 1.6	< 0.6	
Max. laden speed (km/h)	25 (for distance exceeding 6 km within 1h, consult tire manufacturer)						15	10	
Cyclic Load	Yes		Yes	No	Yes	Yes/No	Yes/No	Yes	
Speed	Load[kg]								
0	4380	4380	4380	4380	4380	4380	4380	4380	250/60 - 12/8.00
1	4175	2900	3160	2900	2900	4175	3160	3830	
5	4175	2900	3160	2900	2900	3830	3160	3830	
10	4175	2900	3160	2900	2900	3420	3160	3420	
15	4175	2900	2900	2900	2900	2900	2900	-	
20	3975	2900	2900	2900	2900	2900	-	-	
25	3770	2900	2900	2900	2900	2900	-	-	
0	4530	4530	4530	4530	4530	4530	4530	4530	250/75 - 12/8.00
1	4320	3000	3270	3000	3000	4320	3270	3960	
5	4320	3000	3270	3000	3000	3960	3270	3960	
10	4320	3000	3270	3000	3000	3540	3270	3540	
15	4320	3000	3000	3000	3000	3000	3000	-	
20	4110	3000	3000	3000	3000	3000	-	-	
25	3900	3000	3000	3000	3000	3000	-	-	
0	5210	5210	5210	5210	5210	5210	5210	5210	315/45 - 12/10.00
1	4970	3450	3760	3450	3450	4970	3760	4555	
5	4970	3450	3760	3450	3450	4555	3760	4555	
10	4970	3450	3760	3450	3450	4070	3760	4070	
15	4970	3450	3450	3450	3450	3450	3450	-	
20	4725	3450	3450	3450	3450	3450	-	-	
25	4485	3450	3450	3450	3450	3450	-	-	
0	1735	1735	1735	1735	1735	1735	1735	1735	23 X 5/3.75
1	1655	1150	1255	1150	1150	1655	1255	1520	
5	1655	1150	1255	1150	1150	1520	1255	1520	
10	1655	1150	1255	1150	1150	1355	1255	1355	
15	1655	1150	1150	1150	1150	1150	1150	-	
20	1575	1150	1150	1150	1150	1150	-	-	
25	1495	1150	1150	1150	1150	1150	-	-	

Technical Data Super Elastic Tires

Size range, specifications and tire load capacities

Size	Tire			Rim	Tire dimensions [mm]				
	Pattern	LI	SSY		Article approximate data				
					Usable Tread height	Width	Outer dia.	Static ¹⁾ rad.	Rolling ²⁾ circ.
160/90 - 13/3.75	SC11	-	-	3.75 P-13	-	154	602	284	1910
160/95 - 13/3.75	SC11	-	-	3.75 P-13	-	157	638	300	1992
7.00 - 15/5.50	CS20	143	A5	5.5 - 15	54	176	715	337	2291
	SC15	143	A5	5.5 - 15	52	179	717	345	2282
	SC18	143	A5	5.5 - 15	57	208	745	355	2348
	SC20	143	A5	5.5 - 15	57	177	717	338	2265
7.00 - 15/6.00	SC18	143	A5	6.0 - 15	57	208	745	353	2348

1) At reference load

2) Other vehicles: e.g. trailers, self-propelled machines, tractors, mobile cranes, straddle carriers, forklifts without counterweight, side-loading forklifts etc.

3) For tires used on straddle carriers and straddle fork lifts with max. speed of 25 km/h the load capacity of steered wheels have to be used.

Application	Tire load capacity [kg]								Size	
	Lift Truck		Side Loader	Airport	Port Trailer	Other ² Vehicles	Multi Directional	Gantry Crane		
	Load Wheel	Steer ³ Wheel								
Cycle Length (one way) km	< 1.6		< 1.6	< 2	< 3	< 2	< 1.6	< 0.6		
Max. laden speed (km/h)	25 (for distance exceeding 6 km within 1h, consult tire manufacturer)						15	10		
Cyclic Load	Yes		Yes	No	Yes	Yes/No	Yes/No	Yes		
Speed	Load[kg]									
0	2720	2720	2720	2720	2720	2720	2720	2720	160/90 - 13/3.75	
1	2590	1800	1960	1800	1800	1800	2590	1960		2375
5	2590	1800	1960	1800	1800	1800	2375	1960		2375
10	2590	1800	1960	1800	1800	1800	2125	1960		2125
15	2590	1800	1800	1800	1800	1800	1800	1800		-
20	2465	1800	1800	1800	1800	1800	1800	-		-
25	2340	1800	1800	1800	1800	1800	1800	-		-
0	2720	2720	2720	2720	2720	2720	2720	2720	160/95 - 13/3.75	
1	2590	1800	1960	1800	1800	1800	2590	1960		2375
5	2590	1800	1960	1800	1800	1800	2375	1960		2375
10	2590	1800	1960	1800	1800	1800	2125	1960		2125
15	2590	1800	1800	1800	1800	1800	1800	1800		-
20	2465	1800	1800	1800	1800	1800	1800	-		-
25	2340	1800	1800	1800	1800	1800	1800	-		-
0	4115	4115	4115	4115	4115	4115	4115	4115	7.00 - 15/5.50	
1	3925	2725	2970	2725	2725	2725	3925	2970		3595
5	3925	2725	2970	2725	2725	2725	3595	2970		3595
10	3925	2725	2970	2725	2725	2725	3215	2970		3215
15	3925	2725	2725	2725	2725	2725	2725	2725		-
20	3735	2725	2725	2725	2725	2725	2725	-		-
25	3545	2725	2725	2725	2725	2725	2725	-		-
0	4115	4115	4115	4115	4115	4115	4115	4115	7.00 - 15/6.00	
1	3925	2725	2970	2725	2725	2725	3925	2970		3595
5	3925	2725	2970	2725	2725	2725	3595	2970		3595
10	3925	2725	2970	2725	2725	2725	3215	2970		3215
15	3925	2725	2725	2725	2725	2725	2725	2725		-
20	3735	2725	2725	2725	2725	2725	2725	-		-
25	3545	2725	2725	2725	2725	2725	2725	-		-

Technical Data Super Elastic Tires

Size range, specifications and tire load capacities

Size	Tire			Rim	Tire dimensions [mm]				
	Pattern	LI	SSY		Article approximate data				
					Usable Tread height	Width	Outer dia.	Static ¹⁾ rad.	Rolling ²⁾ circ.
7.50 - 15/6.50	SC18	146	A5	6.5 - 15	57	208	745	354	2349
	SC20	146	A5	6.5 - 15	62	205	746	352	2351
8.25 - 15/6.50	CS20	153	A5	6.5 - 15	74	204	816	381	2569
	SC15	153	A5	6.5 - 15	75	206	819	383	2624
	SC18	153	A5	6.5 - 15	75	206	819	383	2624
	SC20	153	A5	6.5 - 15	75	206	819	383	2579
	SH12	153	A5	6.5 - 15	61	208	809	379	2565
225/75 - 15/7.00	CS20	146	A5	7.0-15	51	211	691	327	2208
	SC15	146	A5	7.0 - 15	47	221	693	329	2221
	SC18	146	A5	7.0 - 15	47	221	693	329	2221
	SC20	146	A5	7.0 - 15	53	216	693	329	2209
250/70 - 15/7.00	CS20	153	A5	7.0 - 15	66	219	718	336	2286
	SC15	153	A5	7.0 - 15	69	221	720	339	2307
	SC18	153	A5	7.0 - 15	69	221	720	339	2307
	SC20	153	A5	7.0 - 15	69	221	720	339	2284

1) At reference load

2) Other vehicles: e.g. trailers, self-propelled machines, tractors, mobile cranes, straddle carriers, forklifts without counterweight, side-loading forklifts etc.

3) For tires used on straddle carriers and straddle fork lifts with max. speed of 25 km/h the load capacity of steered wheels have to be used.

Application	Tire load capacity [kg]								Size
	Lift Truck		Side Loader	Airport	Port Trailer	Other ² Vehicles	Multi Directional	Gantry Crane	
	Load Wheel	Steer ³ Wheel							
Cycle Length (one way) km	< 1.6		< 1.6	< 2	< 3	< 2	< 1.6	< 0.6	
Max. laden speed (km/h)	25 (for distance exceeding 6 km within 1h, consult tire manufacturer)						15	10	
Cyclic Load	Yes		Yes	No	Yes	Yes/No	Yes/No	Yes	
Speed	Load[kg]								
0	4530	4530	4530	4530	4530	4530	4530	4530	7.50 - 15/6.50
1	4320	3000	3270	3000	3000	4320	3270	3960	
5	4320	3000	3270	3000	3000	3960	3270	3960	
10	4320	3000	3270	3000	3000	3540	3270	3540	
15	4320	3000	3000	3000	3000	3000	3000	-	
20	4110	3000	3000	3000	3000	3000	-	-	
25	3900	3000	3000	3000	3000	3000	-	-	
0	5510	5510	5510	5510	5510	5510	5510	5510	8.25 - 15/6.50
1	5255	3650	3980	3650	3650	5255	3980	4820	
5	5255	3650	3980	3650	3650	4820	3980	4820	
10	5255	3650	3980	3650	3650	4305	3980	4305	
15	5255	3650	3650	3650	3650	3650	3650	-	
20	5000	3650	3650	3650	3650	3650	-	-	
25	4745	3650	3650	3650	3650	3650	-	-	
0	4530	4530	4530	4530	4530	4530	4530	4530	225/75 - 15/7.00
1	4320	3000	3270	3000	3000	4320	3270	3960	
5	4320	3000	3270	3000	3000	3960	3270	3960	
10	4320	3000	3270	3000	3000	3540	3270	3540	
15	4320	3000	3000	3000	3000	3000	3000	-	
20	4110	3000	3000	3000	3000	3000	-	-	
25	3900	3000	3000	3000	3000	3000	-	-	
0	5510	5510	5510	5510	5510	5510	5510	5510	250/70 - 15/7.00
1	5255	3650	3980	3650	3650	5255	3980	4820	
5	5255	3650	3980	3650	3650	4820	3980	4820	
10	5255	3650	3980	3650	3650	4305	3980	4305	
15	5255	3650	3650	3650	3650	3650	3650	-	
20	5000	3650	3650	3650	3650	3650	-	-	
25	4745	3650	3650	3650	3650	3650	-	-	

Technical Data Super Elastic Tires

Size range, specifications and tire load capacities

Size	Tire			Rim	Tire dimensions [mm]				
	Pattern	LI	SSY		Article approximate data				
					Usable Tread height	Width	Outer dia.	Static ¹⁾ rad.	Rolling ²⁾ circ.
250/70 - 15/7.50	SC18	153	A5	7.5 - 15	69	221	720	339	2307
	SC20	153	A5	7.5 - 15	68	221	720	338	2298
300 - 15/8.00	SH12	160	A5	8.0 - 15	47	255	811	379	2602
315/70 - 15/8.00	CS20	160	A5	8.0 - 15	73	250	821	384	2597
	SC15	160	A5	8.0 - 15	67	252	823	384	2637
	SC18	160	A5	8.0 - 15	67	252	823	384	2637
	SC20	160	A5	8.0 - 15	74	252	823	386	2594
355/45 - 15/9.75	CS20	159	A5	9.75 - 15	49	291	681	322	2193
	SC18	159	A5	9.75 - 15	46	291	683	324	2199
	SC20	159	A5	9.75 - 15	51	291	683	321	2218
	SH12	159	A5	9.75 - 15	44	291	677	323	2196

1) At reference load

2) Other vehicles: e.g. trailers, self-propelled machines, tractors, mobile cranes, straddle carriers, forklifts without counterweight, side-loading forklifts etc.

3) For tires used on straddle carriers and straddle fork lifts with max. speed of 25 km/h the load capacity of steered wheels have to be used.

Application	Tire load capacity [kg]								Size
	Lift Truck		Side Loader	Airport	Port Trailer	Other ² Vehicles	Multi Directional	Gantry Crane	
	Load Wheel	Steer ³ Wheel							
Cycle Length (one way) km	< 1.6		< 1.6	< 2	< 3	< 2	< 1.6	< 0.6	
Max. laden speed (km/h)	25 (for distance exceeding 6 km within 1h, consult tire manufacturer)						15	10	
Cyclic Load	Yes		Yes	No	Yes	Yes/No	Yes/No	Yes	
Speed	Load[kg]								
0	5510	5510	5510	5510	5510	5510	5510	5510	250/70 - 15/7.50
1	5255	3650	3980	3650	3650	5255	3980	4820	
5	5255	3650	3980	3650	3650	4820	3980	4820	
10	5255	3650	3980	3650	3650	4305	3980	4305	
15	5255	3650	3650	3650	3650	3650	3650	-	
20	5000	3650	3650	3650	3650	3650	-	-	
25	4745	3650	3650	3650	3650	3650	-	-	
0	6795	6795	6795	6795	6795	6795	6795	6795	300 - 15/8.00
1	6480	4500	4905	4500	4500	6480	4905	5940	
5	6480	4500	4905	4500	4500	5940	4905	5940	
10	6480	4500	4905	4500	4500	5310	4905	5310	
15	6480	4500	4500	4500	4500	4500	4500	-	
20	6165	4500	4500	4500	4500	4500	-	-	
25	5850	4500	4500	4500	4500	4500	-	-	
0	6795	6795	6795	6795	6795	6795	6795	6795	315/70 - 15/8.00
1	6480	4500	4905	4500	4500	6480	4905	5940	
5	6480	4500	4905	4500	4500	5940	4905	5940	
10	6480	4500	4905	4500	4500	5310	4905	5310	
15	6480	4500	4500	4500	4500	4500	4500	-	
20	6165	4500	4500	4500	4500	4500	-	-	
25	5850	4500	4500	4500	4500	4500	-	-	
0	6605	6605	6605	6605	6605	6605	6605	6605	355/45 - 15/9.75
1	6300	4375	4770	4375	4375	6300	4770	5775	
5	6300	4375	4770	4375	4375	5775	4770	5775	
10	6300	4375	4770	4375	4375	5165	4770	5165	
15	6300	4375	4375	4375	4375	4375	4375	-	
20	5995	4375	4375	4375	4375	4375	-	-	
25	5690	4375	4375	4375	4375	4375	-	-	

Technical Data Super Elastic Tires

Size range, specifications and tire load capacities

Size	Tire			Rim	Tire dimensions [mm]				
	Pattern	LI	SSY		Article approximate data				
					Usable Tread height	Width	Outer dia.	Static ¹⁾ rad.	Rolling ²⁾ circ.
355/50 - 15/9.75	SC20	159	A5	9.75 - 15	53	291	710	335	2284
355/65 - 15/9.75	CS20	170	A5	9.75 - 15	69	289	820	382	2635
	SC18	170	A5	9.75 - 15	71	291	823	383	2625
	SC20	170	A5	9.75 - 15	71	291	823	383	2621
8.25 - 20/6.50	SC20	153	A5	6.5 - 20	70	210	950	450	2983
9.00 - 20/7.00	SC18	160	A5	7.0 - 20	75	222	990	468	3124

1) At reference load

2) Other vehicles: e.g. trailers, self-propelled machines, tractors, mobile cranes, straddle carriers, forklifts without counterweight, side-loading forklifts etc.

3) For tires used on straddle carriers and straddle fork lifts with max. speed of 25 km/h the load capacity of steered wheels have to be used.

Application	Tire load capacity [kg]								Size
	Lift Truck		Side Loader	Airport	Port Trailer	Other ² Vehicles	Multi Directional	Gantry Crane	
	Load Wheel	Steer ³ Wheel							
Cycle Length (one way) km	< 1.6		< 1.6	< 2	< 3	< 2	< 1.6	< 0.6	
Max. laden speed (km/h)	25 (for distance exceeding 6 km within 1h, consult tire manufacturer)						15	10	
Cyclic Load	Yes		Yes	No	Yes	Yes/No	Yes/No	Yes	
Speed	Load[kg]								
0	6605	6605	6605	6605	6605	6605	6605	6605	355/50 - 15/9.75
1	6300	4375	4770	4375	4375	6300	4770	5775	
5	6300	4375	4770	4375	4375	5775	4770	5775	
10	6300	4375	4770	4375	4375	5165	4770	5165	
15	6300	4375	4375	4375	4375	4375	4375	-	
20	5995	4375	4375	4375	4375	4375	-	-	
25	5690	4375	4375	4375	4375	4375	-	-	
0	9060	9060	9060	9060	9060	9060	9060	9060	355/65 - 15/9.75
1	8640	6000	6540	6000	6000	8640	6540	7920	
5	8640	6000	6540	6000	6000	7920	6540	7920	
10	8640	6000	6540	6000	6000	7080	6540	7080	
15	8640	6000	6000	6000	6000	6000	6000	-	
20	8220	6000	6000	6000	6000	6000	-	-	
25	7800	6000	6000	6000	6000	6000	-	-	
0	5510	5510	5510	5510	5510	5510	5510	5510	8.25 - 20/6.50
1	4820	3650	3980	3650	3650	4820	3980	4820	
5	4820	3650	3980	3650	3650	4455	3980	4820	
10	4820	3650	3980	3650	3650	3980	3980	4305	
15	4820	3650	3650	3650	3650	3650	3650	-	
20	4600	3650	3650	3650	3650	3650	-	-	
25	4380	3650	3650	3650	3650	3650	-	-	
0	6795	6795	6795	6795	6795	6795	6795	6795	9.00 - 20/7.00
1	5940	4500	4905	4500	4500	5940	4905	5940	
5	5940	4500	4905	4500	4500	5940	4905	5940	
10	5940	4500	4905	4500	4500	4905	4905	5310	
15	5940	4500	4500	4500	4500	4500	4500	-	
20	5670	4500	4500	4500	4500	4500	-	-	
25	5400	4500	4500	4500	4500	4500	-	-	

Technical Data Super Elastic Tires

Size range, specifications and tire load capacities

Size	Tire			Rim	Tire dimensions [mm]				
	Pattern	LI	SSY		Article approximate data				
					Usable Tread height	Width	Outer dia.	Static ¹⁾ rad.	Rolling ²⁾ circ.
10.00 - 20/7.50	CT Trailer	164	A5	7.5 - 20	80	244	1012	480	3200
	SC18	164	A5	7.5 - 20	78	265	1025	484	3281
	SC20	164	A5	7.5 - 20	80	265	1030	486	3228
10.00 - 20/8.00	CT Trailer	164	A5	8.0 - 20	80	244	1012	480	3289
	SC18	164	A5	8.0 - 20	78	265	1025	482	3281
	SC20	164	A5	8.0 - 20	80	265	1030	487	3233
12.00 - 20/10.00	SC18	173	A5	10.0 - 20	84	308	1089	514	3444
	SC20	173	A5	10.0 - 20	93	323	1104	521	3488
12.00 - 20/8.00	SC18	172	A5	8.0 - 20	83	270	1089	512	3423
	SC20	172	A5	8.0 - 20	90	283	1104	517	3477

1) At reference load

2) Other vehicles: e.g. trailers, self-propelled machines, tractors, mobile cranes, straddle carriers, forklifts without counterweight, side-loading forklifts etc.

3) For tires used on straddle carriers and straddle fork lifts with max. speed of 25 km/h the load capacity of steered wheels have to be used.

Application	Tire load capacity [kg]								Size
	Lift Truck		Side Loader	Airport	Port Trailer	Other ² Vehicles	Multi Directional	Gantry Crane	
	Load Wheel	Steer ³ Wheel							
Cycle Length (one way) km	< 1.6		< 1.6	< 2	< 3	< 2	< 1.6	< 0.6	
Max. laden speed (km/h)	25 (for distance exceeding 6 km within 1h, consult tire manufacturer)						15	10	
Cyclic Load	Yes		Yes	No	Yes	Yes/No	Yes/No	Yes	
Speed	Load[kg]								
0	7550	7550	7550	7550	7550	7550	7550	7550	10.00 - 20/7.50
1	6600	5000	5450	5000	5000	6600	5450	6600	
5	6600	5000	5450	5000	5000	6100	5450	6600	
10	6600	5000	5450	5000	5000	5450	5450	5900	
15	6600	5000	5000	5000	5000	5000	5000	-	
20	6300	5000	5000	5000	5000	5000	-	-	
25	6000	5000	5000	5000	5000	5000	-	-	
0	7550	7550	7550	7550	7550	7550	7550	7550	10.00 - 20/8.00
1	6600	5000	5450	5000	5000	6600	5450	6600	
5	6600	5000	5450	5000	5000	6100	5450	6600	
10	6600	5000	5450	5000	5000	5450	5450	5900	
15	6600	5000	5000	5000	5000	5000	5000	-	
20	6300	5000	5000	5000	5000	5000	-	-	
25	6000	5000	5000	5000	5000	5000	-	-	
0	9815	9815	9815	9815	9815	9815	9815	9815	12.00 - 20/10.00
1	8580	6500	7085	6500	6500	8580	7085	8580	
5	8580	6500	7085	6500	6500	7930	7085	8580	
10	8580	6500	7085	6500	6500	7085	7085	7670	
15	8580	6500	6500	6500	6500	6500	6500	-	
20	8190	6500	6500	6500	6500	6500	-	-	
25	7800	6500	6500	6500	6500	6500	-	-	
0	9515	9515	9515	9515	9515	9515	9515	9515	12.00 - 20/8.00
1	8315	6300	6865	6300	6300	8315	6865	8315	
5	8315	6300	6865	6300	6300	7685	6865	8315	
10	8315	6300	6865	6300	6300	6865	6865	7435	
15	8315	6300	6300	6300	6300	6300	6300	-	
20	7940	6300	6300	6300	6300	6300	-	-	
25	7560	6300	6300	6300	6300	6300	-	-	

Technical Data Super Elastic Tires

Size range, specifications and tire load capacities

Size	Tire			Rim	Tire dimensions [mm]				
	Pattern	LI	SSY		Article approximate data				
					Usable Tread height	Width	Outer dia.	Static ¹⁾ rad.	Rolling ²⁾ circ.
12.00 - 20/8.50	SC18	172	A5	8.5 - 20	83	270	1089	512	3423
	SC20	172	A5	8.5 - 20	90	283	1104	518	3466
355/50 - 20/10.00	SC20	175	A5	10.0 - 20	43	315	823	390	2680
	SH12	175	A5	10.0 - 20	37	315	823	390	2637
12.00 - 24/10.00	SC20	174	A5	10.0 - 24	93	318	1185	562	3749
12.00 - 24/8.50	SC18	174	A5	8.5 - 24	87	280	1178	555	3720
	SC20	174	A5	8.5 - 24	93	293	1185	559	3741

1) At reference load

2) Other vehicles: e.g. trailers, self-propelled machines, tractors, mobile cranes, straddle carriers, forklifts without counterweight, side-loading forklifts etc.

3) For tires used on straddle carriers and straddle fork lifts with max. speed of 25 km/h the load capacity of steered wheels have to be used.

Application	Tire load capacity [kg]								Size
	Lift Truck		Side Loader	Airport	Port Trailer	Other ² Vehicles	Multi Directional	Gantry Crane	
	Load Wheel	Steer ³ Wheel							
Cycle Length (one way) km	< 1.6		< 1.6	< 2	< 3	< 2	< 1.6	< 0.6	
Max. laden speed (km/h)	25 (for distance exceeding 6 km within 1h, consult tire manufacturer)						15	10	
Cyclic Load	Yes		Yes	No	Yes	Yes/No	Yes/No	Yes	
Speed	Load[kg]								
0	9515	9515	9515	9515	9515	9515	9515	9515	12.00 - 20/8.50
1	8315	6300	6865	6300	6300	8315	6865	8315	
5	8315	6300	6865	6300	6300	7685	6865	8315	
10	8315	6300	6865	6300	6300	6865	6865	7435	
15	8315	6300	6300	6300	6300	6300	6300	-	
20	7940	6300	6300	6300	6300	6300	-	-	
25	7560	6300	6300	6300	6300	6300	-	-	
0	10420	10420	10420	10420	10420	10420	10420	10420	355/50 - 20/10.00
1	9110	6900	7520	6900	6900	9110	7520	9110	
5	9110	6900	7520	6900	6900	9110	7520	9110	
10	9110	6900	7520	6900	6900	8140	7520	8140	
15	9110	6900	6900	6900	6900	6900	6900	-	
20	8970	6900	6900	6900	6900	6900	-	-	
25	8970	6900	6900	6900	6900	6900	-	-	
0	10115	10115	10115	10115	10115	10115	10115	10115	12.00 - 24/10.00
1	8845	6700	7305	6700	6700	8845	7305	8845	
5	8845	6700	7305	6700	6700	8175	7305	8845	
10	8845	6700	7305	6700	6700	7305	7305	7905	
15	8845	6700	6700	6700	6700	6700	6700	-	
20	8440	6700	6700	6700	6700	6700	-	-	
25	8040	6700	6700	6700	6700	6700	-	-	
0	10115	10115	10115	10115	10115	10115	10115	10115	12.00 - 24/8.50
1	8845	6700	7305	6700	6700	8845	7305	8845	
5	8845	6700	7305	6700	6700	8175	7305	8845	
10	8845	6700	7305	6700	6700	7305	7305	7905	
15	8845	6700	6700	6700	6700	6700	6700	-	
20	8440	6700	6700	6700	6700	6700	-	-	
25	8040	6700	6700	6700	6700	6700	-	-	

Technical Data Super Elastic Tires

Size range, specifications and tire load capacities

Size	Tire			Rim	Tire dimensions [mm]				
	Pattern	LI	SSY		Article approximate data				
					Usable Tread height	Width	Outer dia.	Static ¹⁾ rad.	Rolling ²⁾ circ.
14.00 - 24/10.00	SC15	185	A5	10.0 - 24	105	325	1287	598	4127
	SC18	185	A5	10.0 - 24	105	325	1287	603	4082
	SC20	185	A5	10.0 - 24	110	341	1313	616	4134

1) At reference load

2) Other vehicles: e.g. trailers, self-propelled machines, tractors, mobile cranes, straddle carriers, forklifts without counterweight, side-loading forklifts etc.

3) For tires used on straddle carriers and straddle fork lifts with max. speed of 25 km/h the load capacity of steered wheels have to be used.

Application	Tire load capacity [kg]								Size
	Lift Truck		Side Loader	Airport	Port Trailer	Other ² Vehicles	Multi Directional	Gantry Crane	
	Load Wheel	Steer ³ Wheel							
Cycle Length (one way) km	< 1.6		< 1.6	< 2	< 3	< 2	< 1.6	< 0.6	
Max. laden speed (km/h)	25 (for distance exceeding 6 km within 1h, consult tire manufacturer)						15	10	
Cyclic Load	Yes		Yes	No	Yes	Yes/No	Yes/No	Yes	
Speed	Load[kg]								
0	13970	13970	13970	13970	13970	13970	13970	13970	14.00 - 24/10.00
1	12210	9250	10085	9250	9250	12210	10085	12210	
5	12210	9250	10085	9250	9250	11285	10085	12210	
10	12210	9250	10085	9250	9250	10085	10085	10915	
15	12210	9250	9250	9250	9250	9250	9250	-	
20	11655	9250	9250	9250	9250	9250	-	-	
25	11100	9250	9250	9250	9250	9250	-	-	

Technical Data Press-on-Bands

Size range, specifications and tire load capacities

Size ^P		Tire							
		MH20			MC20			ContiPT18	
		mm	inch	STB	z	k	STB	z	k
125/50 - 75	-		●	●					
150/50 - 100	-								
160/50 - 100	-		●	●					
170/75 - 100	-		●			●			
200/75 - 100	-		●	●					
200/85 - 105	-		●	●					
180/50 - 120	-	●	●	●					
230/75 - 120	-		●						
200/50 - 140	-	●	●	●					
250/75 - 140	-	●	●	●					
250/130 - 140	-	●	●						
200/60 - 150	-		●						
265/160 - 160	-	●	●						
254/102 - 165	10X4X6 1/2	●							
254/127 - 165	10X5X6 1/2	●							
267/127 - 165	10 1/2X5X6 1/2	●							
230/50 - 170	-	●	●	●					
250/60 - 170	-		●	●					
260/60 - 170	-		●	●					
230/75 - 170	-	●							
280/75 - 170	-		●	●					
250/80 - 170	-	●	●						
300/85 - 170	-		●						
310/100 - 170	-								

1) Approximate data

2) Other vehicles: platform trucks, tractive units, straddle carriers, fork lifts without counterweight etc

3) Only for intermittent use. Load capacity for sustained use available on request.

4) Max distances 2000 m.

5) Max. distances 2000 m. Standstill of at least three hours between driving cycles

Tire load capacity [kg] at max. speed [km/h]														
Stationary	Handdrawn	on other vehicles ²				Ro-Ro ⁵ : Use	on Fork Lift Trucks ³						Size ⁹	
		6 ⁴ : km/h	10 ⁴ : km/h	16 ⁴ : km/h	max. 10 km/h		max. 16 km/h	max. 25 kmh	inch	mm				
						Load wheel	Steer wheel	Load wheel	Steer wheel	Load wheel	Steer wheel			
-	-	-	-	140	-	-	-	-	-	-	-	-	125/50 - 75	
-	-	-	-	160	-	-	-	-	-	-	-	-	150/50 - 100	
-	-	-	-	170	-	-	-	-	-	-	-	-	160/50 - 100	
-	-	-	-	300	-	-	-	-	-	-	-	-	170/75 - 100	
-	-	500	400	300	-	-	-	-	-	-	-	-	200/75 - 100	
-	-	-	-	410	-	-	-	-	-	-	-	-	200/85 - 105	
-	-	-	-	190	-	-	-	-	-	-	-	-	180/50 - 120	
-	-	-	-	380	-	-	-	-	-	-	-	-	230/75 - 120	
-	-	-	-	200	-	-	-	-	-	-	-	-	200/50 - 140	
-	-	-	-	400	-	-	-	-	-	-	-	-	250/75 - 140	
-	-	-	-	760	-	1065	875	950	800	775	635	-	250/130 - 140	
-	-	-	-	240	-	335	280	300	250	245	200	-	200/60 - 150	
-	-	-	-	1010	-	1410	1160	1260	1060	1030	840	-	265/160 - 160	
-	-	-	-	555	-	780	640	695	585	565	465	10X4X6 1/2	254/102 - 165	
-	-	-	-	725	-	1010	830	905	760	735	605	10X5X6 1/2	254/127 - 165	
-	-	-	-	770	-	1070	880	960	810	780	640	10 1/2X5X6 1/2	267/127 - 165	
-	-	-	-	220	-	-	-	-	-	-	-	-	230/50 - 170	
-	-	-	-	300	-	-	-	-	-	-	-	-	250/60 - 170	
-	-	-	-	310	-	-	-	-	-	-	-	-	260/60 - 170	
-	-	-	-	370	-	-	-	-	-	-	-	-	230/75 - 170	
-	-	-	-	440	-	-	-	-	-	-	-	-	280/75 - 170	
-	-	-	-	440	-	-	-	-	-	-	-	-	250/80 - 170	
-	-	-	-	540	-	-	-	-	-	-	-	-	300/85 - 170	
-	-	-	-	630	-	880	720	790	660	640	520	-	310/100 - 170	

Technical Data Press-on-Bands

Size range, specifications and tire load capacities

Size ^P		Tire								
		MH20			MC20			ContiPT18		
		mm	inch	STB	z	k	STB	z	k	STB
250/105 - 170	-		●							
270/105 - 170	-			●						
250/50 - 190	-			●	●					
250/60 - 190	-		●							
280/60 - 190	-			●						
250/85 - 190	-		●							
310/75 - 200	-				●					
310/120 - 200	-				●					
310/140 - 200	-				●					
300/90 - 203	-			●						
300/100 - 203	-		●	●	●					
330/114 - 203	13X4 1/2X8		●							
356/114 - 203	14X4 1/2X8		●			●				
330/127 - 203	13X5X8					●				
343/140 - 203	13 1/2X5 1/2X8		●		●					
305/114 - 203	12x4 1/2x8		●							
280/50 - 220	-		●	●						
310/60 - 220	-			●						
280/75 - 220	-			●	●					
285/75 - 220	-		●							
300/75 - 220	-			●	●					
310/120 - 220	-			●						
356/127 - 254	14X5X10		●							
16 X 5 X 10½	406/127-267		●							●

1) Approximate data

2) Other vehicles: platform trucks, tractive units, straddle carriers, fork lifts without counterweight etc

3) Only for intermittent use. Load capacity for sustained use available on request.

4) Max distances 2000 m.

5) Max. distances 2000 m. Standstill of at least three hours between driving cycles

Tire load capacity [kg] at max. speed [km/h]													
Stationary	on other vehicles ²					on Fork Lift Trucks ³⁾						Size ⁹⁾	
	Handdrawn	6 ⁴⁾ km/h	10 ⁴⁾ km/h	16 ⁴⁾ km/h	Ro-Ro ⁵⁾ Use	max. 10 km/h		max. 16 km/h		max. 25 kmh			
						Load wheel	Steer wheel	Load wheel	Steer wheel	Load wheel	Steer wheel	inch	mm
-	-	-	-	560	-	780	645	700	585	570	465	-	250/105 - 170
-	-	-	-	610	-	860	700	760	640	620	510	-	270/105 - 170
-	-	-	-	240	-	-	-	-	-	-	-	-	250/50 - 190
-	-	-	-	300	-	-	-	-	-	-	-	-	250/60 - 190
-	-	-	-	330	-	-	-	-	-	-	-	-	280/60 - 190
-	-	-	-	450	-	-	-	-	-	-	-	-	250/85 - 190
-	-	-	-	470	-	-	-	-	-	-	-	-	310/75 - 200
-	-	-	-	810	-	1130	930	1010	850	820	670	-	310/120 - 200
-	-	-	-	980	-	1370	1120	1220	1030	990	820	-	310/140 - 200
-	-	835	685	595	-	835	685	745	625	-	-	-	300/90 - 203
-	-	-	-	620	-	870	710	780	650	630	520	-	300/100 - 203
-	-	-	-	800	-	1120	920	1000	840	815	670	13X4 1/2X8	330/114 - 203
-	-	-	-	830	-	1170	960	1045	875	850	695	14X4 1/2X8	356/114 - 203
-	-	-	-	920	-	1290	1060	1150	965	935	765	13X5X8	330/127 - 203
-	-	-	-	1080	-	1510	1240	1345	1130	1095	895	13 1/2X5 1/2X8	343/140 - 203
-	-	-	-	745	-	1040	855	930	780	755	620	12x4 1/2x8	305/114 - 203
-	-	-	-	260	-	-	-	-	-	-	-	-	280/50 - 220
-	-	-	-	350	-	-	-	-	-	-	-	-	310/60 - 220
-	-	-	-	420	-	-	-	-	-	-	-	-	280/75 - 220
-	-	-	-	440	-	-	-	-	-	-	-	-	285/75 - 220
-	-	-	-	470	-	-	-	-	-	-	-	-	300/75 - 220
-	-	-	-	790	-	1100	900	980	830	800	660	-	310/120 - 220
-	-	-	-	955	-	1335	1095	1195	1000	970	795	14X5X10	356/127 - 254
-	-	-	-	1080	-	1510	1240	1345	1130	1095	895	406/127-267	16 X 5 X 10½

Technical Data Press-on-Bands

Size range, specifications and tire load capacities

Size ^P		Tire						
		MH20			MC20			ContiPT18
mm	inch	STB	z	k	STB	z	k	STB
406/127 - 267	16X5X10 1/2			●	●			
16 X 6 X 10½	406/152-267							●
406/152 - 267	16X6X10 1/2	●		●	●			
406/178 - 267	16X7X10 1/2			●				
16 X 7 X 10½	406/178-267	●						
360/60 - 270	-	●	●	●				
360/75 - 270	-		●	●				
360/85 - 270	-	●	●	●				
16¼ X 6 X 11¼	413/152-286							●
16¼ X 7 X 11¼	413/178-286							●
381/127 - 286	15X5X11 1/4	●			●			
413/127 - 286	16 1/4X5X11 1/4	●			●			
413/152 - 286	16 1/4X6X11 1/4	●			●			
413/178 - 286	16 1/4X7X11 1/4	●			●			
450/120 - 300	-	●						
425/150 - 305	-	●	●					
400/65 - 305	-		●					
405/65 - 305	-	●						
400/75 - 305	-		●	●				
415/75 - 305	-	●						
415/90 - 305	-	●	●					
415/100 - 305	-	●	●	●				
455/100 - 305	-		●					
405/130 - 305	-	●	●					

1) Approximate data

2) Other vehicles: platform trucks, tractive units, straddle carriers, fork lifts without counterweight etc

3) Only for intermittent use. Load capacity for sustained use available on request.

4) Max distances 2000 m.

5) Max. distances 2000 m. Standstill of at least three hours between driving cycles

Tire load capacity [kg] at max. speed [km/h]

Stationary	on other vehicles ²					on Fork Lift Trucks ³⁾						Size ⁹⁾	
	Handdrawn	6 ⁴⁾ km/h	10 ⁴⁾ km/h	16 ⁴⁾ km/h	Ro-Ro ⁵⁾ Use	max. 10 km/h		max. 16 km/h		max. 25 kmh		inch	mm
						Load wheel	Steer wheel	Load wheel	Steer wheel	Load wheel	Steer wheel		
-	-	-	-	1080	-	1510	1240	1345	1130	1095	895	16X5X10 1/2	406/127 - 267
-	-	-	-	1360	-	1910	1570	1710	1435	1390	1140	406/152-267	16 X 6 X 10½
-	-	-	-	1360	-	1910	1570	1710	1435	1390	1140	16X6X10 1/2	406/152 - 267
-	-	-	-	1660	-	2325	1910	2070	1740	1685	1380	16X7X10 1/2	406/178 - 267
-	-	-	-	1660	-	2325	1910	2070	1740	1685	1380	406/178-267	16 X 7 X 10½
-	-	-	-	390	-	-	-	-	-	-	-	-	360/60 - 270
-	-	-	-	535	-	-	-	-	-	-	-	-	360/75 - 270
1110	-	850	700	635	-	-	-	-	-	-	-	-	360/85 - 270
-	-	-	-	1370	-	1920	1580	1715	1440	1395	1140	413/152-286	16¼ X 6 X 11¼
-	-	-	-	1650	-	2325	1900	2060	1735	1680	1380	413/178-286	16¼ X 7 X 11¼
-	-	-	-	990	-	1390	1140	1240	1040	1010	830	15X5X11 1/4	381/127 - 286
-	-	-	-	1090	-	1530	1250	1360	1145	1105	905	16 1/4X5X11 1/4	413/127 - 286
-	-	-	-	1370	-	1920	1580	1715	1440	1395	1140	16 1/4X6X11 1/4	413/152 - 286
-	-	-	-	-	-	-	-	-	-	-	-	16 1/4X7X11 1/4	413/178 - 286
-	-	-	-	1070	-	1500	1230	1340	1130	1090	890	-	450/120 - 300
-	-	-	-	1365	-	1910	1570	1700	1435	1385	1135	-	425/150 - 305
-	-	-	-	470	-	-	-	-	-	-	-	-	400/65 - 305
-	790	-	-	470	-	-	-	-	-	-	-	-	405/65 - 305
-	-	-	-	580	-	-	-	-	-	-	-	-	400/75 - 305
-	-	-	-	590	-	-	-	-	-	-	-	-	415/75 - 305
-	-	-	-	760	-	-	-	-	-	-	-	-	415/90 - 305
-	-	-	-	795	-	1115	915	1000	835	810	665	-	415/100 - 305
-	-	-	-	830	-	1160	950	1030	870	840	690	-	455/100 - 305
-	-	-	-	1080	-	1510	1240	1350	1135	1095	900	-	405/130 - 305

Technical Data Press-on-Bands

Size range, specifications and tire load capacities

Size ^P		Tire						
		MH20			MC20			ContiPT18
mm	inch	STB	z	k	STB	z	k	STB
405/260 - 305	-	●						
425/260 - 305	-	●						
425/300 - 305	-	●						
450/300 - 305	-	●						
457/127 - 308	18X5X12 1/8	●			●			
18 X 6 X 12½	457/152-308							●
457/152 - 308	18X6X12 1/8	●			●			
18 X 7 X 12½	457/178-308							●
457/178 - 308	18X7X12 1/8	●			●			
18 X 8 X 12½	457/203-308							●
457/203 - 308	18X8X12 1/8	●			●			
18 X 9 X 12½	457/229-308							●
457/229 - 308	18X9X12 1/8	●			●			
500/85 - 370	-		●					
520/100 - 370	-	●	●					
500/320 - 370	-	●						
500/360 - 370	-	●						
500/420 - 370	-	●						
533/127 - 381	21X5X15	●						
533/152 - 381	21X6X15				●			
21 X 7 X 15	533/178-381							●
533/178 - 381	21X7X15	●			●			
21 X 8 X 15	533/203-381							●
533/203 - 381	21X8X15	●			●			

1) Approximate data

2) Other vehicles: platform trucks, tractive units, straddle carriers, fork lifts without counterweight etc

3) Only for intermittent use. Load capacity for sustained use available on request.

4) Max distances 2000 m.

5) Max. distances 2000 m. Standstill of at least three hours between driving cycles

Tire load capacity [kg] at max. speed [km/h]															
on other vehicles ²						on Fork Lift Trucks ³⁾						Size ⁹⁾			
Stationary	Handdrawn	6 ⁴⁾ km/h	10 ⁴⁾ km/h	16 ⁴⁾ km/h	Ro-Ro ⁵⁾ Use	max. 10 km/h		max. 16 km/h		max. 25 kmh		inch	mm		
						Load wheel	Steer wheel	Load wheel	Steer wheel	Load wheel	Steer wheel				
-	-	-	-	2375	-	3325	2730	2970	2495	2415	1980	-	405/260 - 305		
-	-	-	-	2585	-	3620	2970	3230	2715	2630	2155	-	425/260 - 305		
-	-	-	-	3030	-	4245	3485	3790	3185	3085	2530	-	425/300 - 305		
-	-	4640	3810	3320	-	4640	3810	4150	3480	3370	2760	-	450/300 - 305		
-	-	-	-	1170	-	1640	1350	1470	1230	1195	980	18X5X12 1/8	457/127 - 308		
-	-	-	-	1500	-	2100	1720	1870	1575	1525	1250	457/152-308	18 X 6 X 12½		
-	-	-	-	1500	-	2100	1720	1870	1575	1525	1250	18X6X12 1/8	457/152 - 308		
-	-	-	-	1820	-	2550	2100	2280	1910	1855	1520	457/178-308	18 X 7 X 12½		
-	-	-	-	1820	-	2550	2100	2280	1910	1855	1520	18X7X12 1/8	457/178 - 308		
-	-	-	-	2150	-	3000	2475	2680	2250	2180	1790	457/203-308	18 X 8 X 12½		
-	-	-	-	2150	-	3000	2475	2680	2250	2180	1790	18X8X12 1/8	457/203 - 308		
-	-	-	-	2475	-	3450	2850	3090	2600	2510	2060	457/229-308	18 X 9 X 12½		
-	-	-	-	2475	-	3450	2850	3090	2600	2510	2060	18X9X12 1/8	457/229 - 308		
-	-	-	-	785	-	-	-	-	-	-	-	-	500/85 - 370		
-	-	-	-	910	-	1280	1050	1140	960	930	760	-	520/100 - 370		
-	-	-	-	3750	-	5250	4310	4690	3940	3810	3130	-	500/320 - 370		
-	-	-	-	4270	-	5980	4910	5340	4480	4340	3560	-	500/360 - 370		
-	-	-	-	5040	-	7060	5800	6300	5300	5130	4200	-	500/420 - 370		
-	-	-	-	1320	-	1840	1510	1640	1385	1335	1095	21X5X15	533/127 - 381		
-	-	-	-	1680	-	2350	1930	2100	1765	1710	1400	21X6X15	533/152 - 381		
-	-	-	-	2050	-	2875	2350	2560	2150	2085	1710	533/178-381	21 X 7 X 15		
-	-	-	-	2050	-	2875	2350	2560	2150	2085	1710	21X7X15	533/178 - 381		
-	-	-	-	2425	-	3375	2775	3025	2540	2455	2015	533/203-381	21 X 8 X 15		
-	-	-	-	2255	-	3160	2595	2820	2370	2295	1880	21X8X15	533/203 - 381		

Technical Data Press-on-Bands

Size range, specifications and tire load capacities

Size ^P		Tire									
		MH20			MC20			ContiPT18			
		mm	inch	STB	z	k	STB	z	k	STB	
21 X 9 X 15	533/229-381										●
533/229 - 381	21X9X15	●									
559/152 - 406	22X6X16	●									
559/203 - 406	22X8X16	●			●						
559/229 - 406	22X9X16	●			●						
559/254 - 406	22X10X16	●			●						
559/305 - 406	22X12X16	●			●						
559/356 - 406	22X14X16	●									
559/406 - 406	22X16X16	●									
22 X 8 X 16	559/203-406										●
22 X 9 X 16	559/229-406										●
22 X 12 X 16	559/305-406										●
500/65 - 410	-	●	●								
560/100 - 410	-	●	●								
550/120 - 410	-		●	●							
590/120 - 410	-		●								
610/150 - 410	-	●	●								
550/160 - 410	-	●	●								
540/200 - 410	-		●								
620/200 - 410	-	●									
645/250 - 410	-	●	●								
645/300 - 410	-	●									
645/200 - 480	-	●						●			
645/250 - 480	-	●									

1) Approximate data

2) Other vehicles: platform trucks, tractive units, straddle carriers, fork lifts without counterweight etc

3) Only for intermittent use. Load capacity for sustained use available on request.

4) Max distances 2000 m.

5) Max. distances 2000 m. Standstill of at least three hours between driving cycles

Tire load capacity [kg] at max. speed [km/h]															
on other vehicles ²						on Fork Lift Trucks ³⁾						Size ⁹⁾			
Stationary	Handdrawn	6 ⁴ km/h	10 ⁴ km/h	16 ⁴ km/h	Ro-Ro ⁵⁾ Use	max. 10 km/h		max. 16 km/h		max. 25 kmh		inch	mm		
						Load wheel	Steer wheel	Load wheel	Steer wheel	Load wheel	Steer wheel				
-	-	-	-	2775	-	3900	3200	3475	2920	2830	2320	533/229-381	21 X 9 X 15		
-	-	3900	3200	2775	-	3900	3200	3475	2920	2830	2320	21X9X15	533/229 - 381		
-	-	-	-	1740	-	2450	2000	2180	1830	1770	1450	22X6X16	559/152 - 406		
-	-	-	-	2500	-	3500	2875	3130	2625	2545	2085	22X8X16	559/203 - 406		
-	-	-	-	2875	-	4050	3325	3600	3025	2930	2400	22X9X16	559/229 - 406		
-	-	-	-	3250	-	4575	3750	4080	3425	3315	2720	22X10X16	559/254 - 406		
-	-	-	-	4025	-	5625	4625	5030	4225	4090	3350	22X12X16	559/305 - 406		
-	-	-	-	4785	-	6700	5505	5980	5025	4865	3990	22X14X16	559/356 - 406		
-	-	-	-	5530	-	7745	6360	6915	5810	5625	4610	22X16X16	559/406 - 406		
-	-	-	-	2500	-	3500	2875	3130	2625	2545	2085	559/203-406	22 X 8 X 16		
-	-	-	-	2875	-	4050	3325	3600	3025	2930	2400	559/229-406	22 X 9 X 16		
-	-	-	-	4025	-	5625	4625	5030	4225	4090	3350	559/305-406	22 X 12 X 16		
-	-	-	-	560	-	-	-	-	-	-	-	-	500/65 - 410		
-	-	-	-	960	-	1350	1110	1205	1015	-	-	-	560/100 - 410		
-	-	-	-	1250	-	1750	1440	1565	1315	1270	1040	-	550/120 - 410		
-	-	-	-	1270	-	1780	1460	1590	1340	1290	1060	-	590/120 - 410		
-	-	-	-	1790	-	2505	2055	2235	1880	1815	1490	-	610/150 - 410		
-	-	-	-	1825	-	2550	2100	2280	1915	1855	1520	-	550/160 - 410		
-	-	-	-	2335	-	3270	2685	2920	2450	2375	1945	-	540/200 - 410		
-	-	-	-	2770	-	3880	3190	3460	2910	2820	2310	-	620/200 - 410		
7245	---	---	---	3125	---	4810	3930	4180	3430	3305	2745	-	645/250 - 410		
-	-	-	-	3935	-	6060	4960	5275	4330	4170	3460	-	645/300 - 410		
-	-	-	-	2760	-	3865	3175	3450	2900	2800	2295	-	645/200 - 480		
-	-	-	-	3105	-	4780	3910	4160	3415	3290	2735	-	645/250 - 480		

Technical Data Press-on-Bands

Size range, specifications and tire load capacities

Size ¹⁾		Tire						
		MH20			MC20			ContiPT18
mm	inch	STB	z	k	STB	z	k	STB
620/420 - 480	-	●						
760/250 - 500	-	●						
711/254 - 559	28X10X22	●						
711/305 - 559	28X12X22	●			●			
711/356 - 559	28X14X22	●						
840/356 - 559	-	●						
711/406 - 559	28 X 16 X 22	●						
840/406 - 559	-	●						
840/500 - 559	-	●						
920/250 - 670	-	●						
920/400 - 670	-	●						
1016/406 - 762	40x16x30	●						

1) Approximate data

2) Other vehicles: platform trucks, tractive units, straddle carriers, fork lifts without counterweight etc

3) Only for intermittent use. Load capacity for sustained use available on request.

4) Max distances 2000 m.

5) Max. distances 2000 m. Standstill of at least three hours between driving cycles

Tire load capacity [kg] at max. speed [km/h]													
Stationary	on other vehicles ²					on Fork Lift Trucks ³						Size ¹	
	Handdrawn	6 ⁴ km/h	10 ⁴ km/h	16 ⁴ km/h	Ro-Ro ⁵ Use	max. 10 km/h		max. 16 km/h		max. 25 kmh			
						Load wheel	Steer wheel	Load wheel	Steer wheel	Load wheel	Steer wheel	inch	mm
-	-	-	-	6055	-	8480	6965	7570	6360	6160	5050	-	620/420 - 480
-	-	-	-	3530	-	5440	4450	4730	3885	3740	3105	-	760/250 - 500
-	-	-	-	3905	-	5470	4490	4880	4100	3970	3255	28X10X22	711/254 - 559
-	-	-	-	4820	-	6740	5540	6020	5060	4900	4015	28X12X22	711/305 - 559
-	-	-	-	5720	-	8020	6590	7160	6020	5820	4780	28X14X22	711/356 - 559
-	-	-	-	6030	-	9290	7600	8090	6640	6400	5310	-	840/356 - 559
-	-	-	-	6620	-	9270	7620	8280	6950	6730	5520	28 X 16 X 22	711/406 - 559
-	-	10920	8930	7090	-	10920	8930	9500	7800	7520	6240	-	840/406 - 559
-	-	-	-	9080	-	13980	11440	12160	9990	9620	7990	-	840/500 - 559
-	-	-	-	4080	-	6280	5140	5465	4485	4320	3590	-	920/250 - 670
-	-	-	-	7335	-	11290	9240	9825	8065	7775	6455	-	920/400 - 670
-	-	-	-	8060	-	12420	10160	10810	8870	8550	7095	40x16x30	1016/406 - 762

Industrial Radial Pneumatic Tires



ContiRT20



- › Excellent transmission of traction forces from vehicle to ground, especially on uneven surfaces
- › High stability due to interlinked tread blocks
- › Ready for tire sensor usage to measure tire temperature and air pressure



Angled pocket sipes

Optimum traction performance and steering capabilities in both summer and winter conditions



Interlocked tread blocks

Increased traction and better braking performance in all weather conditions due to tread block orientation

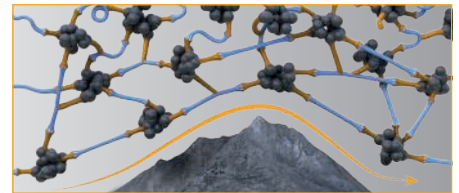

Increased durability

Innovative tread compound for resistance to severe wear and tread cracking caused by stress tears or foreign objects



ContiRV20 Velocity



- › Low energy consumption
- › Wet grip and traction
- › Excellent comfort and handling
- › Damage resistance
- › High productivity and minimal total operating cost
- › Ready for TSR usage



Radial tire construction for ultra-efficient transmission of drive forces

Reduced energy consumption and CO2 emission output thanks to low-rolling resistance rubber compounds

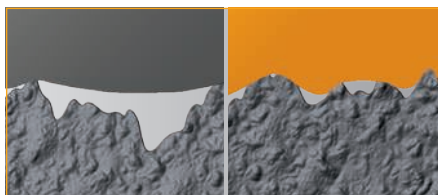

Molecular tread compound that grips structure of road surface

Ribbed tread profile for permanent contact with ground surface

Wet grip and traction



Ribbed tread pattern for smooth road contact

Radial tire construction provides optimum damping and driving comfort

Closed shoulder to avoid tearing and elimination of heel and toe wear

Industrial Radial Pneumatic Tires



ContiRV20 All Season



- › Extra traction and performance in winter conditions
- › Three-rib tread with multiple sipes offers maximum ground contact and traction no matter what the weather conditions
- › M+S marking on the sidewall as verified symbol for all-season performance

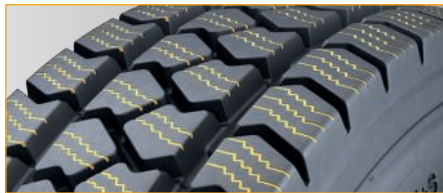

Angled pocket sipes

Optimum traction performance and steering capabilities in both summer and winter conditions

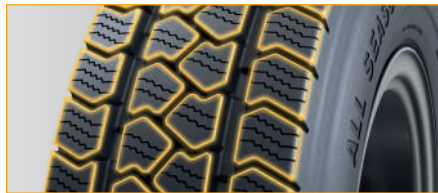

Interlocked tread blocks

Increased traction and better braking performance in all weather conditions due to tread block orientation



Circumferential 3-rib design

High comfort and steering capabilities due to ribs and large number of tread pattern blocks



TerminalMaster



- › For heavy-duty applications, especially in port terminal operations
- › S-shaped cross ribs allow excellent traction in all conditions and all weather conditions
- › The closed-shoulder design ensures high resistance to tire scrubs during tight maneuvers
- › Wide tread grooves prevent trapping of foreign objects

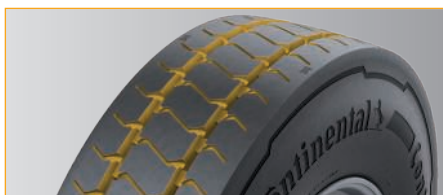

Distinctive S-shaped cross ribs

The distinctive S-shaped cross ribs create numerous grip edges for outstanding traction.



Deep tread depth and reinforced sidewall

Deep tread depth provides increased mileage and added puncture resistance. Reinforced sidewalls provide additional protection from foreign objects.



Closed-shoulder design

Wide shoulder ribs provide resistance to tire abrasion during maneuvers and prevent uneven wear.

Industrial Radial Pneumatic Tires



Terminal Transport



- › Low rolling resistance
- › Excellent grip
- › Good traction
- › High driving comfort
- › Even wear
- › Reasonable price



TerminalMaster AP*



- › Maximum service hours due to wide and strong tire design with deep tread
- › High fuel efficiency and low emissions as a result of the optimized, low-rolling-resistance tread compound
- › High transfer of torque from the tire to ground surface via five longitudinal tread ribs, ensuring excellent traction under load



IC70*



- › Good traction
- › Excellent driving comfort
- › Reduced heat generation
- › Energy saving



ConRad HT1*



- › Low heat generation
- › Lower rolling resistance
- › Longer wear
- › Cost-efficient
- › Special tread pattern for dual fitment

*Niche application for selected sizes



Technical Data Industrial Radial Tires

Size range, specifications and tire load capacities

Tire									Tire dimensions [mm]					
Size	Pattern	Tire Type	LI	SSY	Rim	Tube	Flap	TSR *	Article approximate data					
									Tread depth	Width	Outer dia.	Static ^D rad.	Rolling ^D circ.	Min. Dual Spacing
125/75 R 8	IC70	TL	100	A5	3.00 D-8	S15x4 ½ - 8; 125 / 75-	B 85 - 8 s	TSR 3.00 / 3.25 TL 8	5.1	120	386	176	1181	138
5.00 R 8	IC70	TL	111	A5	3.00 D-8	S5.00 - 8 Fs	B 85 - 8	TSR 3.00 TL 8	8.2	132	461	209	1410	158
150/75 R 8	IC70	TL	113	A5	4.33 R-8	S16x6-8; 18x7-8 F	B 115 - 8	TSR 4.33 TL 8	7.4	150	425	193	1299	175
180/70 R 8	ContiIRT20	TL	125	A5	4.33 R-8	S 16x6-8; 18x7-8 F	B 115-8	TSR 4.33 TL 8	19.0	173	461	205	1406	199
180/70 R 8	ContiRV20	TL	125	A5	4.33 R-8	S 16x6-8 / 18x7-8 F	B 115-8	TSR 4.33 TL 8	13.0	171	464	208	1415	199
6.00 R 9	ContiIRT20	TL	121	A5	4.00 E-9	S 6.00-9; 21x8-9	B 100-9s	TSR 4.00 TL 9	24.5	162	539	248	1644	192

*) Use only in combination with tires compatible with Continental TSR system

1) At reference load.

2) Please contact Continental Technical Customer Center or Sales department for further information.

Inflation Pressure [bar]	Application	Reach Stackers, Counterbalanced Lift Trucks, Loaded Container Handlers, Empty Container Handlers		Rubber Tire Gantry Crane	Straddle/Shuttle Carriers	Ro-Ro Terminal Tractors	Terminal Tractors and Trailers	Automated Guided Vehicles (AGVs)	Sider Loader (Fork lift/Reach stacker)	Towbar Airport Tractor	Towbarless airport tractor	Small Ground Support Airport Tractor	Hot slag transporter	Heavy lift transport	Other vehicles	Please consult Continental	Size											
		Load Wheel	Steer Wheel																									
		Cycle Length (one way) km	1,6															0,6	2,5	2,5	2,5	1,6	1,6	7,0	7,0	2,0	3,0	10,0
		Max. laden speed (km/h)	25															8	35	20	40	25	30	32	32	30	15	3
Cyclic Load	Yes	Yes	Yes	Yes	Yes	Yes	Yes	Yes	No	Yes	No	Yes	No															
Speed	Load[kg]															Size												
10	Static	1200	960	0	0	0	0	0	0	0	2)	800	0	0	2)	125/75 R 8												
	1	1040	840	0	0	0	0	0	0	0	2)	800	0	0	2)													
	5	1040	840	0	0	0	0	0	0	0	2)	800	0	0	2)													
	10	1040	840	0	0	0	0	0	0	0	2)	800	0	0	2)													
	20	1040	800	0	0	0	0	0	0	0	2)	800	0	0	2)													
	25	1040	800	0	0	0	0	0	0	0	2)	800	0	0	2)													
	35	1000	740	0	0	0	0	0	0	0	2)	740	0	0	2)													
	40	0	0	0	0	0	0	0	0	0	2)	0	0	0	2)													
50	0	0	0	0	0	0	0	0	0	2)	0	0	0	2)														
10	Static	1635	1310	0	0	0	0	0	0	0	2)	1090	0	0	2)	5.00 R 8												
	1	1420	1145	0	0	0	0	0	0	0	2)	1090	0	0	2)													
	5	1420	1145	0	0	0	0	0	0	0	2)	1090	0	0	2)													
	10	1420	1145	0	0	0	0	0	0	0	2)	1090	0	0	2)													
	20	1420	1090	0	0	0	0	0	0	0	2)	1090	0	0	2)													
	25	1420	1090	0	0	0	0	0	0	0	2)	1090	0	0	2)													
	35	1365	1010	0	0	0	0	0	0	0	2)	1010	0	0	2)													
	40	0	0	0	0	0	0	0	0	0	2)	0	0	0	2)													
50	0	0	0	0	0	0	0	0	0	2)	0	0	0	2)														
10	Static	1725	1380	0	0	0	0	0	0	0	2)	1150	0	0	2)	150/75 R 8												
	1	1495	1210	0	0	0	0	0	0	0	2)	1150	0	0	2)													
	5	1495	1210	0	0	0	0	0	0	0	2)	1150	0	0	2)													
	10	1495	1210	0	0	0	0	0	0	0	2)	1150	0	0	2)													
	20	1495	1150	0	0	0	0	0	0	0	2)	1150	0	0	2)													
	25	1495	1150	0	0	0	0	0	0	0	2)	1150	0	0	2)													
	35	1440	1065	0	0	0	0	0	0	0	2)	1065	0	0	2)													
	40	0	0	0	0	0	0	0	0	0	2)	0	0	0	2)													
50	0	0	0	0	0	0	0	0	0	2)	0	0	0	2)														
10	Static	2475	1980	0	0	0	0	2)	0	0	2)	1650	0	0	2)	180/70 R 8												
	1	2145	1735	0	0	0	0	2)	0	0	2)	1650	0	0	2)													
	5	2145	1735	0	0	0	0	2)	0	0	2)	1650	0	0	2)													
	10	2145	1735	0	0	0	0	2)	0	0	2)	1650	0	0	2)													
	20	2145	1650	0	0	0	0	2)	0	0	2)	1650	0	0	2)													
	25	2145	1650	0	0	0	0	2)	0	0	2)	1650	0	0	2)													
	35	2065	1530	0	0	0	0	2)	0	0	2)	1530	0	0	2)													
	40	0	0	0	0	0	0	2)	0	0	2)	0	0	0	2)													
50	0	0	0	0	0	0	2)	0	0	2)	0	0	0	2)														
10	Static	2475	1980	0	0	0	0	2)	0	0	2)	1650	0	0	2)	180/70 R 8												
	1	2145	1735	0	0	0	0	2)	0	0	2)	1650	0	0	2)													
	5	2145	1735	0	0	0	0	2)	0	0	2)	1650	0	0	2)													
	10	2145	1735	0	0	0	0	2)	0	0	2)	1650	0	0	2)													
	20	2145	1650	0	0	0	0	2)	0	0	2)	1650	0	0	2)													
	25	2145	1650	0	0	0	0	2)	0	0	2)	1650	0	0	2)													
	35	2065	1530	0	0	0	0	2)	0	0	2)	1530	0	0	2)													
	40	0	0	0	0	0	0	2)	0	0	2)	0	0	0	2)													
50	0	0	0	0	0	0	2)	0	0	2)	0	0	0	2)														
10	Static	2175	1740	0	0	0	0	2)	0	0	2)	1450	0	0	2)	6.00 R 9												
	1	1885	1525	0	0	0	0	2)	0	0	2)	1450	0	0	2)													
	5	1885	1525	0	0	0	0	2)	0	0	2)	1450	0	0	2)													
	10	1885	1525	0	0	0	0	2)	0	0	2)	1450	0	0	2)													
	20	1885	1450	0	0	0	0	2)	0	0	2)	1450	0	0	2)													
	25	1885	1450	0	0	0	0	2)	0	0	2)	1450	0	0	2)													
	35	1815	1345	0	0	0	0	2)	0	0	2)	1345	0	0	2)													
	40	0	0	0	0	0	0	2)	0	0	2)	0	0	0	2)													
50	0	0	0	0	0	0	2)	0	0	2)	0	0	0	2)														

Technical Data Industrial Radial Tires

Size range, specifications and tire load capacities

Tire									Tire dimensions [mm]					
Size	Pattern	Tire Type	LI	SSY	Rim	Tube	Flap	TSR *	Article approximate data					
									Tread depth	Width	Outer dia.	Static ¹⁾ rad.	Rolling ²⁾ circ.	Min. Dual Spacing
6.00 R 9	ContiRV20	TL	121	A5	4.00 E-9	S 6.00-9 / 21x8-9 T S 6.00-9 / 21x8-9 S	B 100-9 s -	TSR 4.00 TL 9 -	14.5	163	532	244	1620	192
6.00 R 9	ContiRV20 AllSeason	TL	121	A5	4.00 E-9	S 6.00-9 / 21x8-9 T S 6.00-9 / 21x8-9 F	B 100-9 s -	TSR 4.00 TL 9 -	14.5	163	532	244	1620	192
160/85 R 10	ContiRV20	TL	129	A5	5.00 F 10	S 6.50 / 7.50 - 10 F Valve 60D (V3-02-19)	B 130 - 10 -	TSR 10 Radial TL -	14.5	170	534	242	1626	184
6.50 R 10	ContiIRT20	TL	128	A5	5.00 F-10	S 6.50 / 7.50-10 Fs -	B 130-10 -	TSR 5.00 / 5.50 TL 10 -	29.0	181	590	272	1800	212
6.50 R 10	ContiRV20	TL	128	A5	5.00 F-10	S 6.50 / 7.50-10 Fs S 6.50 / 7.50-10 F	B 130-10 s -	TSR 5.00 / 5.50 TL 10 -	16.0	183	586	269	1783	212
6.50 R 10	ContiRV20 AllSeason	TL	128	A5	5.00 F-10	S 6.50 / 7.50-10 Fs S 6.50 / 7.50-10 F	B 130-10 s -	TSR 5.00 / 5.50 TL -	16.0	183	586	269	1783	212

*) Use only in combination with tires compatible with Continental TSR system

1) At reference load.

2) Please contact Continental Technical Customer Center or Sales department for further information.

Inflation Pressure [bar]	Application	Reach Stackers, Counterbalanced Lift Trucks, Loaded Container Handlers, Empty Container Handlers		Rubber Tire Gantry Crane	Straddle/Shuttle Carriers	Ro-Ro Terminal Tractors	Terminal Tractors and Trailers	Automated Guided Vehicles (AGVs)	Sider Loader (Fork lift/Reach stacker)	Towbar Airport Tractor	Towbarless airport tractor	Small Ground Support Airport Tractor	Hot slag transporter	Heavy lift transport	Other vehicles	Please consult Continental	Size
		Load Wheel	Steer Wheel														
		Cycle Length (one way) km	25														
	Yes	Yes	Yes	Yes	Yes	Yes	Yes	Yes	No	Yes	No	Yes	No				
	Speed	Load[kg]														Size	
10	Static	2175	1740	0	0	0	0	2)	0	0	2)	1450	0	0	2)	6.00 R 9	
	1	1885	1525	0	0	0	0	2)	0	0	2)	1450	0	0	2)		
	5	1885	1525	0	0	0	0	2)	0	0	2)	1450	0	0	2)		
	10	1885	1525	0	0	0	0	2)	0	0	2)	1450	0	0	2)		
	20	1885	1450	0	0	0	0	2)	0	0	2)	1450	0	0	2)		
	25	1885	1450	0	0	0	0	2)	0	0	2)	1450	0	0	2)		
	35	1815	1345	0	0	0	0	2)	0	0	2)	1345	0	0	2)		
	40	0	0	0	0	0	0	2)	0	0	2)	0	0	0	2)		
10	Static	2175	1740	0	0	0	0	2)	0	0	2)	1450	0	0	2)	6.00 R 9	
	1	1885	1525	0	0	0	0	2)	0	0	2)	1450	0	0	2)		
	5	1885	1525	0	0	0	0	2)	0	0	2)	1450	0	0	2)		
	10	1885	1525	0	0	0	0	2)	0	0	2)	1450	0	0	2)		
	20	1885	1450	0	0	0	0	2)	0	0	2)	1450	0	0	2)		
	25	1885	1450	0	0	0	0	2)	0	0	2)	1450	0	0	2)		
	35	1815	1345	0	0	0	0	2)	0	0	2)	1345	0	0	2)		
	40	0	0	0	0	0	0	2)	0	0	2)	0	0	0	2)		
10,0	Static											1850				160/85 R 10	
	1											1850					
	5											1850					
	10											1850					
	20											1850					
	25											1850					
	35											1715					
	40																
10	Static	2700	2160	0	0	0	0	2)	0	0	2)	1800	0	0	2)	6.50 R 10	
	1	2340	1890	0	0	0	0	2)	0	0	2)	1800	0	0	2)		
	5	2340	1890	0	0	0	0	2)	0	0	2)	1800	0	0	2)		
	10	2340	1890	0	0	0	0	2)	0	0	2)	1800	0	0	2)		
	20	2340	1800	0	0	0	0	2)	0	0	2)	1800	0	0	2)		
	25	2340	1800	0	0	0	0	2)	0	0	2)	1800	0	0	2)		
	35	2250	1665	0	0	0	0	2)	0	0	2)	1665	0	0	2)		
	40	0	0	0	0	0	0	2)	0	0	2)	0	0	0	2)		
10	Static	2700	2160	0	0	0	0	2)	0	0	2)	1800	0	0	2)	6.50 R 10	
	1	2340	1890	0	0	0	0	2)	0	0	2)	1800	0	0	2)		
	5	2340	1890	0	0	0	0	2)	0	0	2)	1800	0	0	2)		
	10	2340	1890	0	0	0	0	2)	0	0	2)	1800	0	0	2)		
	20	2340	1800	0	0	0	0	2)	0	0	2)	1800	0	0	2)		
	25	2340	1800	0	0	0	0	2)	0	0	2)	1800	0	0	2)		
	35	2250	1665	0	0	0	0	2)	0	0	2)	1665	0	0	2)		
	40	0	0	0	0	0	0	2)	0	0	2)	0	0	0	2)		
10	Static	2700	2160	0	0	0	0	2)	0	0	2)	1800	0	0	2)	6.50 R 10	
	1	2340	1890	0	0	0	0	2)	0	0	2)	1800	0	0	2)		
	5	2340	1890	0	0	0	0	2)	0	0	2)	1800	0	0	2)		
	10	2340	1890	0	0	0	0	2)	0	0	2)	1800	0	0	2)		
	20	2340	1800	0	0	0	0	2)	0	0	2)	1800	0	0	2)		
	25	2340	1800	0	0	0	0	2)	0	0	2)	1800	0	0	2)		
	35	2250	1665	0	0	0	0	2)	0	0	2)	1665	0	0	2)		
	40	0	0	0	0	0	0	2)	0	0	2)	0	0	0	2)		

Technical Data Industrial Radial Tires

Size range, specifications and tire load capacities

Tire									Tire dimensions [mm]					
Size	Pattern	Tire Type	LI	SSY	Rim	Tube	Flap	TSR *	Article approximate data					
									Tread depth	Width	Outer dia.	Static ¹⁾ rad.	Rolling ²⁾ circ.	Min. Dual Spacing
225/75 R 10	ContiIRT20	TL	142	A5	6.50 F-10	S 23X9-10 / 225 / 75-10	B 180-10	TSR 6.50 TL 10	24.0	221	592	266	1805	262
225/75 R 10	ContiRV20	TL	142	A5	6.50 F-10	S23x9-10; 225 / 75-10F	B 180-10	TSR 6.50 TL 10	16.5	226	586	261	1763	262
7.00 R 12	ContiIRT20	TL	136	A5	5.00 S-12	S 7.00-12 F	B 130-12	TSR 5.00 TL 12	29.0	192	675	311	2057	230
7.00 R 12	ContiRV20	TL	136	A5	5.00 S-12	S 7.00-12 F	B 130-12	TSR 5.00 TL 12	17.0	195	669	307	2045	230
7.00 R 12	ContiRV20 AllSeason	TL	136	A5	5.00 S 12	S 7.00-12 F	B 130 - 12	TSR 5.00 TL 12	17.0	195	669	307	205	230
7.00 R 12	IC70	TL	136	A5	5.00 S-12	S7.00 - 12 F	B 130 - 12	TSR 5.00 TL 12	11.5	193	660	302	2018	230

*) Use only in combination with tires compatible with Continental TSR system

1) At reference load.

2) Please contact Continental Technical Customer Center or Sales department for further information.

Inflation Pressure [bar]	Application	Reach Stackers, Counterbalanced Lift Trucks, Loaded Container Handlers, Empty Container Handlers		Rubber Tire Gantry Crane	Straddle/Shuttle Carriers	Ro-Ro Terminal Tractors	Terminal Tractors and Trailers	Automated Guided Vehicles (AGVs)	Sider Loader (Fork lift/Reach stacker)	Towbar Airport Tractor	Towbarless airport tractor	Small Ground Support Airport Tractor	Hot slag transporter	Heavy lift transport	Other vehicles	Please consult Continental	Size											
		Load Wheel	Steer Wheel																									
		Cycle Length (one way) km	1,6															0,6	2,5	2,5	2,5	1,6	1,6	7,0	7,0	2,0	3,0	10,0
		Max. laden speed (km/h)	25															8	35	20	40	25	30	32	32	30	15	3
Cyclic Load	Yes	Yes	Yes	Yes	Yes	Yes	Yes	Yes	No	Yes	No	Yes	No															
Speed	Load[kg]															Size												
10	Static	3975	3180	0	0	0	0	2)	0	0	2)	2650	0	0	2)	225/75 R 10												
	1	3445	2785	0	0	0	0	2)	0	0	2)	2650	0	0	2)													
	5	3445	2785	0	0	0	0	2)	0	0	2)	2650	0	0	2)													
	10	3445	2785	0	0	0	0	2)	0	0	2)	2650	0	0	2)													
	20	3445	2650	0	0	0	0	2)	0	0	2)	2650	0	0	2)													
	25	3445	2650	0	0	0	0	2)	0	0	2)	2650	0	0	2)													
	35	3315	2455	0	0	0	0	2)	0	0	2)	2455	0	0	2)													
	40	0	0	0	0	0	0	2)	0	0	2)	0	0	0	2)													
10	Static	3975	3180	0	0	0	0	2)	0	0	2)	2650	0	0	2)	225/75 R 10												
	1	3445	2785	0	0	0	0	2)	0	0	2)	2650	0	0	2)													
	5	3445	2785	0	0	0	0	2)	0	0	2)	2650	0	0	2)													
	10	3445	2785	0	0	0	0	2)	0	0	2)	2650	0	0	2)													
	20	3445	2650	0	0	0	0	2)	0	0	2)	2650	0	0	2)													
	25	3445	2650	0	0	0	0	2)	0	0	2)	2650	0	0	2)													
	35	3315	2455	0	0	0	0	2)	0	0	2)	2455	0	0	2)													
	40	0	0	0	0	0	0	2)	0	0	2)	0	0	0	2)													
10	Static	3360	2690	0	0	0	0	0	3360	0	0	2240	0	0	2)	7.00 R 12												
	1	2915	2355	0	0	0	0	0	2580	0	0	2240	0	0	2)													
	5	2915	2355	0	0	0	0	0	2580	0	0	2240	0	0	2)													
	10	2915	2355	0	0	0	0	0	2580	0	0	2240	0	0	2)													
	20	2915	2240	0	0	0	0	0	2465	0	0	2240	0	0	2)													
	25	2915	2240	0	0	0	0	0	2240	0	0	2240	0	0	2)													
	35	2800	2075	0	0	0	0	0	2075	0	0	2075	0	0	2)													
	40	0	0	0	0	0	0	0	0	0	0	0	0	0	2)													
10	Static	3360	2690	0	0	0	0	0	3360	0	0	2240	0	0	2)	7.00 R 12												
	1	2915	2355	0	0	0	0	0	2580	0	0	2240	0	0	2)													
	5	2915	2355	0	0	0	0	0	2580	0	0	2240	0	0	2)													
	10	2915	2355	0	0	0	0	0	2580	0	0	2240	0	0	2)													
	20	2915	2240	0	0	0	0	0	2465	0	0	2240	0	0	2)													
	25	2915	2240	0	0	0	0	0	2240	0	0	2240	0	0	2)													
	35	2800	2075	0	0	0	0	0	2075	0	0	2075	0	0	2)													
	40	0	0	0	0	0	0	0	0	0	0	0	0	0	2)													
10	Static	3360	2690	0	0	0	0	0	3360	0	0	2240	0	0	2)	7.00 R 12												
	1	2915	2355	0	0	0	0	0	2580	0	0	2240	0	0	2)													
	5	2915	2355	0	0	0	0	0	2580	0	0	2240	0	0	2)													
	10	2915	2355	0	0	0	0	0	2580	0	0	2240	0	0	2)													
	20	2915	2240	0	0	0	0	0	2465	0	0	2240	0	0	2)													
	25	2915	2240	0	0	0	0	0	2240	0	0	2240	0	0	2)													
	35	2800	2075	0	0	0	0	0	2075	0	0	2075	0	0	2)													
	40	0	0	0	0	0	0	0	0	0	0	0	0	0	2)													
10	Static	3360	2690	0	0	0	0	0	3360	0	0	2240	0	0	2)	7.00 R 12												
	1	2915	2355	0	0	0	0	0	2580	0	0	2240	0	0	2)													
	5	2915	2355	0	0	0	0	0	2580	0	0	2240	0	0	2)													
	10	2915	2355	0	0	0	0	0	2580	0	0	2240	0	0	2)													
	20	2915	2240	0	0	0	0	0	2465	0	0	2240	0	0	2)													
	25	2915	2240	0	0	0	0	0	2240	0	0	2240	0	0	2)													
	35	2800	2075	0	0	0	0	0	2075	0	0	2075	0	0	2)													
	40	0	0	0	0	0	0	0	0	0	0	0	0	0	2)													
10	Static	3360	2690	0	0	0	0	0	3360	0	0	2240	0	0	2)	7.00 R 12												
	1	2915	2355	0	0	0	0	0	2580	0	0	2240	0	0	2)													
	5	2915	2355	0	0	0	0	0	2580	0	0	2240	0	0	2)													
	10	2915	2355	0	0	0	0	0	2580	0	0	2240	0	0	2)													
	20	2915	2240	0	0	0	0	0	2465	0	0	2240	0	0	2)													
	25	2915	2240	0	0	0	0	0	2240	0	0	2240	0	0	2)													
	35	2800	2075	0	0	0	0	0	2075	0	0	2075	0	0	2)													
	40	0	0	0	0	0	0	0	0	0	0	0	0	0	2)													

Technical Data Industrial Radial Tires

Size range, specifications and tire load capacities

Tire									Tire dimensions [mm]					
Size	Pattern	Tire Type	LI	SSY	Rim	Tube	Flap	TSR *	Article approximate data					
									Tread depth	Width	Outer dia.	Static rad. ^D	Rolling ^D circ.	Min. Dual Spacing
250/75 R 12	ContiIRT20	TL	152	A5	8.00 G-12	S 27x10-12; 250 / 75-1 -	B 220-12s -	TSR 8.00 TL 12 -	29.0	261	686	310	2092	300
165 R 13	ContiRV20	TL	102	A6	4.50 x 13 B	- / - -	- / - -	- -	18.0	167	598	280	1836	192
165 R 13	ContiRV20 AllSeason	TL	102	A6	4.50 x 13 B	- / - -	- / - -	- -	18.0	167	598	280	1836	192
7.00 R 15	ContiIRT20	TL	143	A5	5.5 - 15	S 7.00-15; 200-15 F -	B 170-15 reinf. -	TSR 5.50 TL 15 -	17.0	199	731	336	2229	236
7.00 R 15	ContiRV20	TL	143	A5	5.5 - 15	S 7.00-15 / 200-15 F -	B 170-15 reinf. -	TSR 5.50 TL 15 -	17.0	201	731	337	2238	236
7.50 R 15	ContiIRT20	TL	146	A5	6.0 - 15	S 7.50-15; 250 / 70-15; B 170-15 reinf. -	B 170-15 reinf. -	TSR 6.00 / 6.50 TL 15 -	30.0	208	770	349	2309	254

*) Use only in combination with tires compatible with Continental TSR system

1) At reference load.

2) Please contact Continental Technical Customer Center or Sales department for further information.

Inflation Pressure [bar]	Application	Reach Stackers, Counterbalanced Lift Trucks, Loaded Container Handlers, Empty Container Handlers		Rubber Tire Gantry Crane	Straddle/Shuttle Carriers	Ro-Ro Terminal Tractors	Terminal Tractors and Trailers	Automated Guided Vehicles (AGVs)	Sider Loader (Fork lift/Reach stacker)	Towbar Airport Tractor	Towbarless airport tractor	Small Ground Support Airport Tractor	Hot slag transporter	Heavy lift transport	Other vehicles	Please consult Continental	Size											
		Load Wheel	Steer Wheel																									
		Cycle Length (one way) km	1,6															0,6	2,5	2,5	2,5	1,6	1,6	7,0	7,0	2,0	3,0	10,0
		Max. laden speed (km/h)	25															8	35	20	40	25	30	32	32	30	15	3
Cyclic Load	Yes	Yes	Yes	Yes	Yes	Yes	Yes	Yes	No	Yes	No	Yes	No															
Speed	Load[kg]															Size												
10	Static	5325	4260	0	0	0	0	2)	5325	3550	5325	3550	2)	2)	2)	250/75 R 12												
	1	4615	3730	0	0	0	0	2)	4085	3550	4615	3550	2)	2)	2)													
	5	4615	3730	0	0	0	0	2)	4085	3550	4615	3550	2)	2)	2)													
	10	4615	3730	0	0	0	0	2)	4085	3550	4615	3550	2)	2)	2)													
	20	4615	3550	0	0	0	0	2)	3905	3550	3550	3550	2)	2)	2)													
	25	4615	3550	0	0	0	0	2)	3550	3550	3550	3550	2)	2)	2)													
	35	4440	3285	0	0	0	0	2)	3285	3285	3285	3285	2)	2)	2)													
	40	0	0	0	0	0	0	2)	0	0	0	0	2)	2)	2)													
4,5	Static	0	0	0	0	0	0	0	0	0	0	850	0	0	2)	165 R 13												
	1	0	0	0	0	0	0	0	0	0	0	850	0	0	2)													
	5	0	0	0	0	0	0	0	0	0	0	850	0	0	2)													
	10	0	0	0	0	0	0	0	0	0	0	850	0	0	2)													
	20	0	0	0	0	0	0	0	0	0	0	850	0	0	2)													
	25	0	0	0	0	0	0	0	0	0	0	850	0	0	2)													
	35	0	0	0	0	0	0	0	0	0	0	790	0	0	2)													
	40	0	0	0	0	0	0	0	0	0	0	0	0	0	2)													
4,5	Static	0	0	0	0	0	0	0	0	0	0	850	0	0	2)	165 R 13												
	1	0	0	0	0	0	0	0	0	0	0	850	0	0	2)													
	5	0	0	0	0	0	0	0	0	0	0	850	0	0	2)													
	10	0	0	0	0	0	0	0	0	0	0	850	0	0	2)													
	20	0	0	0	0	0	0	0	0	0	0	850	0	0	2)													
	25	0	0	0	0	0	0	0	0	0	0	850	0	0	2)													
	35	0	0	0	0	0	0	0	0	0	0	790	0	0	2)													
	40	0	0	0	0	0	0	0	0	0	0	0	0	0	2)													
10	Static	4090	3270	0	0	0	2)	2)	4090	2725	4090	2725	2)	2)	2)	7.00 R 15												
	1	3545	2865	0	0	0	2)	2)	3135	2725	3545	2725	2)	2)	2)													
	5	3545	2865	0	0	0	2)	2)	3135	2725	3545	2725	2)	2)	2)													
	10	3545	2865	0	0	0	2)	2)	3135	2725	3545	2725	2)	2)	2)													
	20	3545	2725	0	0	0	2)	2)	3000	2725	2725	2725	2)	2)	2)													
	25	3545	2725	0	0	0	2)	2)	2725	2725	2725	2725	2)	2)	2)													
	35	3410	2525	0	0	0	2)	2)	2525	2525	2525	2525	2)	2)	2)													
	40	0	0	0	0	0	2)	2)	0	0	0	0	2)	2)	2)													
10	Static	4090	3270	0	0	0	2)	2)	4090	2725	4090	2725	2)	2)	2)	7.00 R 15												
	1	3545	2865	0	0	0	2)	2)	3135	2725	3545	2725	2)	2)	2)													
	5	3545	2865	0	0	0	2)	2)	3135	2725	3545	2725	2)	2)	2)													
	10	3545	2865	0	0	0	2)	2)	3135	2725	3545	2725	2)	2)	2)													
	20	3545	2725	0	0	0	2)	2)	3000	2725	2725	2725	2)	2)	2)													
	25	3545	2725	0	0	0	2)	2)	2725	2725	2725	2725	2)	2)	2)													
	35	3410	2525	0	0	0	2)	2)	2525	2525	2525	2525	2)	2)	2)													
	40	0	0	0	0	0	2)	2)	0	0	0	0	2)	2)	2)													
10	Static	4500	3600	0	0	0	2)	2)	4500	3000	4500	3000	2)	2)	2)	7.50 R 15												
	1	3900	3150	0	0	0	2)	2)	3450	3000	3900	3000	2)	2)	2)													
	5	3900	3150	0	0	0	2)	2)	3450	3000	3900	3000	2)	2)	2)													
	10	3900	3150	0	0	0	2)	2)	3450	3000	3900	3000	2)	2)	2)													
	20	3900	3000	0	0	0	2)	2)	3300	3000	3000	3000	2)	2)	2)													
	25	3900	3000	0	0	0	2)	2)	3000	3000	3000	3000	2)	2)	2)													
	35	3750	2775	0	0	0	2)	2)	2775	2775	2775	2775	2)	2)	2)													
	40	0	0	0	0	0	2)	2)	0	0	0	0	2)	2)	2)													
50	0	0	0	0	0	2)	2)	0	0	0	0	2)	2)	2)														

Technical Data Industrial Radial Tires

Size range, specifications and tire load capacities

Tire									Tire dimensions [mm]					
Size	Pattern	Tire Type	LI	SSY	Rim	Tube	Flap	TSR *	Article approximate data					
									Tread depth	Width	Outer dia.	Static ¹⁾ rad.	Rolling ¹⁾ circ.	Min. Dual Spacing
7.50 R 15	ContiRV20	TL	146	A5	6.0 - 15	S 7.50-15; 250 / 70-15; -	B 170-15 reinf. -	TSR 6.00 / 6.50 TL 15 -	19.5	219	770	353	2357	254
8.25 R 15	CONRAD HT1	TL	153	A5	6.5 - 15	8.25-15 -	B 170 - 15 reinf. -	TSR6.50 TL 15 -	35.0	238	842	388	2602	281
8.25 R 15	ContiIRT20	TL	153	A5	6.5 - 15	S 8.25-15 F -	B 170-15 reinf. -	TSR 6.50 TL 15 -	34.5	237	834	381	2543	281
8.25 R 15	ContiRV20	TL	153	A5	6.5 - 15	8.25-15 -	B 170-15 reinf. -	TSR 6.50 TL 15 -	35.0	238	842	385	2577	281
225/75 R 15	ContiIRT20	TL	149	A5	7.0 - 15	S 7.50-15; 250 / 70-15; 2 -	B 190-15 reinf. -	TSR 7.00 TL 15 reinf -	25.0	222	721	330	2199	268
250/70 R 15	ContiIRT20	TL	153	A5	7.0 - 15	S 7.50-15; 250 / 70-15; -	B 190-15 reinf. -	TSR 7.00 / 7.50 TL 15 -	28.0	242	740	338	2257	289

*) Use only in combination with tires compatible with Continental TSR system

1) At reference load.

2) Please contact Continental Technical Customer Center or Sales department for further information.

Inflation Pressure [bar]	Application	Reach Stackers, Counterbalanced Lift Trucks, Loaded Container Handlers, Empty Container Handlers		Rubber Tire Gantry Crane	Straddle/Shuttle Carriers	Ro-Ro Terminal Tractors	Terminal Tractors and Trailers	Automated Guided Vehicles (AGVs)	Sider Loader (Fork lift/Reach stacker)	Towbar Airport Tractor	Towbarless airport tractor	Small Ground Support Airport Tractor	Hot slag transporter	Heavy lift transport	Other vehicles	Size
		Load Wheel	Steer Wheel													
	Cycle Length (one way) km	1,6		0,6	2,5	2,5	2,5	1,6	1,6	7,0	7,0	2,0	3,0	10,0		
	Max. laden speed (km/h)	25		8	35	20	40	25	30	32	32	30	15	3		
	Cyclic Load	Yes		Yes	Yes	Yes	Yes	Yes	Yes	No	Yes	No	Yes	No	Please consult Continental	
	Speed	Load[kg]														
10	Static	4500	3600	0	0	0	2)	2)	4500	3000	4500	3000	2)	2)	2)	7.50 R 15
	1	3900	3150	0	0	0	2)	2)	3450	3000	3900	3000	2)	2)	2)	
	5	3900	3150	0	0	0	2)	2)	3450	3000	3900	3000	2)	2)	2)	
	10	3900	3150	0	0	0	2)	2)	3450	3000	3900	3000	2)	2)	2)	
	20	3900	3000	0	0	0	2)	2)	3300	3000	3000	3000	2)	2)	2)	
	25	3900	3000	0	0	0	2)	2)	3000	3000	3000	3000	2)	2)	2)	
	35	3750	2775	0	0	0	2)	2)	2775	2775	2775	2775	2)	2)	2)	
	40	0	0	0	0	0	2)	2)	0	0	0	0	2)	2)	2)	
10	Static	5475	4380	0	0	0	2)	2)	5475	3650	5475	3650	2)	5475	2)	8.25 R 15
	1	4745	3835	0	0	0	2)	2)	4200	3650	4745	3650	2)	4745	2)	
	5	4745	3835	0	0	0	2)	2)	4200	3650	4745	3650	2)	4745	2)	
	10	4745	3835	0	0	0	2)	2)	4200	3650	4745	3650	2)	3835	2)	
	20	4745	3650	0	0	0	2)	2)	4015	3650	3650	3650	2)	3650	2)	
	25	4745	3650	0	0	0	2)	2)	3650	3650	3650	3650	2)	3650	2)	
	35	4565	3380	0	0	0	2)	2)	3380	3380	3380	3380	2)	0	2)	
	40	0	0	0	0	0	2)	2)	0	0	0	0	2)	0	2)	
10	Static	5475	4380	0	0	0	2)	2)	5475	3650	5475	3650	2)	5475	2)	8.25 R 15
	1	4745	3835	0	0	0	2)	2)	4200	3650	4745	3650	2)	4745	2)	
	5	4745	3835	0	0	0	2)	2)	4200	3650	4745	3650	2)	4745	2)	
	10	4745	3835	0	0	0	2)	2)	4200	3650	4745	3650	2)	3835	2)	
	20	4745	3650	0	0	0	2)	2)	4015	3650	3650	3650	2)	3650	2)	
	25	4745	3650	0	0	0	2)	2)	3650	3650	3650	3650	2)	3650	2)	
	35	4565	3380	0	0	0	2)	2)	3380	3380	3380	3380	2)	0	2)	
	40	0	0	0	0	0	2)	2)	0	0	0	0	2)	0	2)	
10	Static	5475	4380	0	0	0	2)	2)	5475	3650	5475	3650	2)	5475	2)	8.25 R 15
	1	4745	3835	0	0	0	2)	2)	4200	3650	4745	3650	2)	4745	2)	
	5	4745	3835	0	0	0	2)	2)	4200	3650	4745	3650	2)	4745	2)	
	10	4745	3835	0	0	0	2)	2)	4200	3650	4745	3650	2)	3835	2)	
	20	4745	3650	0	0	0	2)	2)	4015	3650	3650	3650	2)	3650	2)	
	25	4745	3650	0	0	0	2)	2)	3650	3650	3650	3650	2)	3650	2)	
	35	4565	3380	0	0	0	2)	2)	3380	3380	3380	3380	2)	0	2)	
	40	0	0	0	0	0	2)	2)	0	0	0	0	2)	0	2)	
10	Static	4875	3900	0	0	0	0	2)	4875	3250	4875	3250	2)	2)	2)	225/75 R 15
	1	4225	3415	0	0	0	0	2)	3740	3250	4225	3250	2)	2)	2)	
	5	4225	3415	0	0	0	0	2)	3740	3250	4225	3250	2)	2)	2)	
	10	4225	3415	0	0	0	0	2)	3740	3250	4225	3250	2)	2)	2)	
	20	4225	3250	0	0	0	0	2)	3575	3250	3250	3250	2)	2)	2)	
	25	4225	3250	0	0	0	0	2)	3250	3250	3250	3250	2)	2)	2)	
	35	4065	3010	0	0	0	0	2)	3010	3010	3010	3010	2)	2)	2)	
	40	0	0	0	0	0	0	2)	0	0	0	0	2)	2)	2)	
10	Static	5475	4380	0	0	0	2)	2)	5475	3650	5475	3650	0	0	2)	250/70 R 15
	1	4745	3835	0	0	0	2)	2)	4200	3650	4745	3650	0	0	2)	
	5	4745	3835	0	0	0	2)	2)	4200	3650	4745	3650	0	0	2)	
	10	4745	3835	0	0	0	2)	2)	4200	3650	4745	3650	0	0	2)	
	20	4745	3650	0	0	0	2)	2)	4015	3650	3650	3650	0	0	2)	
	25	4745	3650	0	0	0	2)	2)	3650	3650	3650	3650	0	0	2)	
	35	4565	3380	0	0	0	2)	2)	3380	3380	3380	3380	0	0	2)	
	40	0	0	0	0	0	2)	2)	0	0	0	0	0	0	2)	
50	0	0	0	0	0	2)	2)	0	0	0	0	0	0	2)		

Technical Data Industrial Radial Tires

Size range, specifications and tire load capacities

Tire									Tire dimensions [mm]					
Size	Pattern	Tire Type	LI	SSY	Rim	Tube	Flap	TSR *	Article approximate data					
									Tread depth	Width	Outer dia.	Static ^D rad.	Rolling ^D circ.	Min. Dual Spacing
250/70 R 15	ContiRV20	TL	153	A5	7.0 - 15	28x9-15 / 250 / 70-15	B 190-15 reinf.	TSR 7.00 / 7.50 TL 15	25.0	240	743	338	2274	289
315/70 R 15	ContiRT20	TL	165	A5	8.0 - 15	S300-15; 355 / 65-15 F	B 240-15 reinf.	TSR 8.00 TL 15 reinf	35.0	313	836	374	2550	354
315/70 R 15	ContiRV20	TL	165	A5	8.0 - 15	S 300-15 / 355 / 65-15	B 240-15 reinf.	TSR 8.00TL 15 reinf.	30.0	304	830	368	2540	354
355/65 R 15	ContiRT20	TL	170	A5	9.75 - 15	S 300-15; 355 / 65-15 F	B 240-15 reinf.	TSR 9.75 Radial TL 1	35.0	336	839	366	2558	407
225/75 R 16	ContiRV20	TL	116	A8	6 J x 16	-	-	-	19.5	220	747	354	2262	256
225/75 R 16	ContiRV20 AllSeason	TL	116	A8	6 J x 16	-	-	-	19.5	220	747	354	2262	256

*) Use only in combination with tires compatible with Continental TSR system

1) At reference load.

2) Please contact Continental Technical Customer Center or Sales department for further information.

Inflation Pressure [bar]	Application	Reach Stackers, Counterbalanced Lift Trucks, Loaded Container Handlers, Empty Container Handlers		Rubber Tire Gantry Crane	Straddle/Shuttle Carriers	Ro-Ro Terminal Tractors	Terminal Tractors and Trailers	Automated Guided Vehicles (AGVs)	Sider Loader (Fork lift/Reach stacker)	Towbar Airport Tractor	Towbarless airport tractor	Small Ground Support Airport Tractor	Hot slag transporter	Heavy lift transport	Other vehicles	Please consult Continental	Size										
		Load Wheel	Steer Wheel																								
		Cycle Length (one way) km	1,6															0,6	2,5	2,5	1,6	1,6	7,0	7,0	2,0	3,0	10,0
		Max. laden speed (km/h)	25															8	35	20	40	25	30	32	32	30	15
Cyclic Load	Yes	Yes	Yes	Yes	Yes	Yes	Yes	Yes	No	Yes	No	Yes	No														
	Speed	Load[kg]																									
10	Static	5475	4380	0	0	0	2)	2)	5475	3650	5475	3650	0	0	2)	250/70 R 15											
	1	4745	3835	0	0	0	2)	2)	4200	3650	4745	3650	0	0	2)												
	5	4745	3835	0	0	0	2)	2)	4200	3650	4745	3650	0	0	2)												
	10	4745	3835	0	0	0	2)	2)	4200	3650	4745	3650	0	0	2)												
	20	4745	3650	0	0	0	2)	2)	4015	3650	3650	3650	0	0	2)												
	25	4745	3650	0	0	0	2)	2)	3650	3650	3650	3650	0	0	2)												
	35	4565	3380	0	0	0	2)	2)	3380	3380	3380	3380	0	0	2)												
	40	0	0	0	0	0	2)	2)	0	0	0	0	0	0	2)												
10	Static	7725	6180	0	0	0	2)	2)	7725	5150	7725	2)	0	7725	2)	315/70 R 15											
	1	6695	5410	0	0	0	2)	2)	5925	5150	6695	2)	0	6695	2)												
	5	6695	5410	0	0	0	2)	2)	5925	5150	6695	2)	0	6695	2)												
	10	6695	5410	0	0	0	2)	2)	5925	5150	6695	2)	0	5410	2)												
	20	6695	5150	0	0	0	2)	2)	5665	5150	5150	2)	0	5150	2)												
	25	6695	5150	0	0	0	2)	2)	5150	5150	5150	2)	0	5150	2)												
	35	6440	4765	0	0	0	2)	2)	4765	4765	4765	2)	0	0	2)												
	40	0	0	0	0	0	2)	2)	0	0	0	2)	0	0	2)												
10	Static	7725	6180	0	0	0	2)	2)	7725	5150	7725	2)	0	7725	2)	315/70 R 15											
	1	6695	5410	0	0	0	2)	2)	5925	5150	6695	2)	0	6695	2)												
	5	6695	5410	0	0	0	2)	2)	5925	5150	6695	2)	0	6695	2)												
	10	6695	5410	0	0	0	2)	2)	5925	5150	6695	2)	0	5410	2)												
	20	6695	5150	0	0	0	2)	2)	5665	5150	5150	2)	0	5150	2)												
	25	6695	5150	0	0	0	2)	2)	5150	5150	5150	2)	0	5150	2)												
	35	6440	4765	0	0	0	2)	2)	4765	4765	4765	2)	0	0	2)												
	40	0	0	0	0	0	2)	2)	0	0	0	2)	0	0	2)												
10	Static	9000	7200	0	0	0	2)	2)	9000	6000	9000	2)	2)	9000	2)	355/65 R 15											
	1	7800	6300	0	0	0	2)	2)	6900	6000	7800	2)	2)	7800	2)												
	5	7800	6300	0	0	0	2)	2)	6900	6000	7800	2)	2)	7800	2)												
	10	7800	6300	0	0	0	2)	2)	6900	6000	7800	2)	2)	6300	2)												
	20	7800	6000	0	0	0	2)	2)	6600	6000	6000	2)	2)	6000	2)												
	25	7800	6000	0	0	0	2)	2)	6000	6000	6000	2)	2)	6000	2)												
	35	7500	5550	0	0	0	2)	2)	5550	5550	5550	2)	2)	0	2)												
	40	0	0	0	0	0	2)	2)	0	0	0	2)	2)	0	2)												
6,5	Static	0	0	0	0	0	0	2)	0	0	0	1250	0	0	2)	225/75 R 16											
	1	0	0	0	0	0	0	2)	0	0	0	1250	0	0	2)												
	5	0	0	0	0	0	0	2)	0	0	0	1250	0	0	2)												
	10	0	0	0	0	0	0	2)	0	0	0	1250	0	0	2)												
	20	0	0	0	0	0	0	2)	0	0	0	1250	0	0	2)												
	25	0	0	0	0	0	0	2)	0	0	0	1250	0	0	2)												
	35	0	0	0	0	0	0	2)	0	0	0	1160	0	0	2)												
	40	0	0	0	0	0	0	2)	0	0	0	0	0	0	2)												
6,5	Static	0	0	0	0	0	0	2)	0	0	0	1250	0	0	2)	225/75 R 16											
	1	0	0	0	0	0	0	2)	0	0	0	1250	0	0	2)												
	5	0	0	0	0	0	0	2)	0	0	0	1250	0	0	2)												
	10	0	0	0	0	0	0	2)	0	0	0	1250	0	0	2)												
	20	0	0	0	0	0	0	2)	0	0	0	1250	0	0	2)												
	25	0	0	0	0	0	0	2)	0	0	0	1250	0	0	2)												
	35	0	0	0	0	0	0	2)	0	0	0	1160	0	0	2)												
	40	0	0	0	0	0	0	2)	0	0	0	0	0	0	2)												

Technical Data Industrial Radial Tires

Size range, specifications and tire load capacities

Tire									Tire dimensions [mm]					
Size	Pattern	Tire Type	LI	SSY	Rim	Tube	Flap	TSR *	Article approximate data					
									Tread depth	Width	Outer dia.	Static ¹⁾ rad.	Rolling ²⁾ circ.	Min. Dual Spacing
8.75 R16.5	ContiRV20	TL	128	A8	6.75 x 16.5	- / - -	- / - -	- / - -	19.5	224	759	353	2320	255
8.75 R16.5	ContiRV20 AllSeason	TL	128	A8	6.75 x 16.5	- / - -	- / - -	- / - -	19.5	224	759	353	2320	255
10.00 R 20	ContiIRT20	TL	166	A5	7.5 - 20	S 10.00-20 F -	B 190-20 rein. -	TSR 20* Radial TL re -	35.0	289	1069	495	3260	333
11.00 R 20	ContiIRT20	TL	169	A5	8.0 - 20	S 11.00-20 F -	B 230-20 rein. -	TSR 20* Radial TL 20 -	38.0	288	1094	505	3336	353
12.00 R 20	CONRAD HT1	TL	176	A5	8.5 - 20	11.00 / 12.00-20 -	B 230-20 rein. -	TSR 20* Radial TL 20 -	36.0	311	1140	518	3487	379
12.00 R 20	ContiIRT20	TL	176	A5	8.5 - 20	S 12.00-20 F -	B 230-20 rein. -	TSR 20* Radial TL 20 -	40.0	308	1143	522	3486	379

*) Use only in combination with tires compatible with Continental TSR system

1) At reference load.

2) Please contact Continental Technical Customer Center or Sales department for further information.

Inflation Pressure [bar]	Application	Reach Stackers, Counterbalanced Lift Trucks, Loaded Container Handlers, Empty Container Handlers		Rubber Tire Gantry Crane	Straddle/Shuttle Carriers	Ro-Ro Terminal Tractors	Terminal Tractors and Trailers	Automated Guided Vehicles (AGVs)	Sider Loader (Fork lift/Reach stacker)	Towbar Airport Tractor	Towbarless airport tractor	Small Ground Support Airport Tractor	Hot slag transporter	Heavy lift transport	Other vehicles	Please consult Continental	Size											
		Load Wheel	Steer Wheel																									
		Cycle Length (one way) km	1,6															0,6	2,5	2,5	2,5	1,6	1,6	7,0	7,0	2,0	3,0	10,0
		Max. laden speed (km/h)	25															8	35	20	40	25	30	32	32	30	15	3
Cyclic Load	Yes	Yes	Yes	Yes	Yes	Yes	Yes	Yes	No	Yes	No	Yes	No															
Speed	Load[kg]															Size												
6,6	Static	0	0	0	0	0	0	2)	0	0	0	1800	0	0	2)	8.75 R16.5												
	1	0	0	0	0	0	0	2)	0	0	0	1800	0	0	2)													
	5	0	0	0	0	0	0	2)	0	0	0	1800	0	0	2)													
	10	0	0	0	0	0	0	2)	0	0	0	1800	0	0	2)													
	20	0	0	0	0	0	0	2)	0	0	0	1800	0	0	2)													
	25	0	0	0	0	0	0	2)	0	0	0	1800	0	0	2)													
	35	0	0	0	0	0	0	2)	0	0	0	1665	0	0	2)													
	40	0	0	0	0	0	0	2)	0	0	0	0	0	0	2)													
6,6	Static	0	0	0	0	0	0	2)	0	0	0	1800	0	0	2)	8.75 R16.5												
	1	0	0	0	0	0	0	2)	0	0	0	1800	0	0	2)													
	5	0	0	0	0	0	0	2)	0	0	0	1800	0	0	2)													
	10	0	0	0	0	0	0	2)	0	0	0	1800	0	0	2)													
	20	0	0	0	0	0	0	2)	0	0	0	1800	0	0	2)													
	25	0	0	0	0	0	0	2)	0	0	0	1800	0	0	2)													
	35	0	0	0	0	0	0	2)	0	0	0	1665	0	0	2)													
	40	0	0	0	0	0	0	2)	0	0	0	0	0	0	2)													
10	Static	7950	6360	0	0	2)	2)	2)	7950	5300	7950	0	2)	7950	2)	10.00 R 20												
	1	6890	5565	0	0	2)	2)	2)	6095	5300	6890	0	2)	6890	2)													
	5	6890	5565	0	0	2)	2)	2)	6095	5300	6890	0	2)	6890	2)													
	10	6890	5565	0	0	2)	2)	2)	6095	5300	6890	0	2)	5565	2)													
	20	6890	5300	0	0	2)	2)	2)	5830	5300	5300	0	2)	5300	2)													
	25	6890	5300	0	0	2)	2)	2)	5300	5300	5300	0	2)	5300	2)													
	35	6625	4905	0	0	2)	2)	2)	4905	4905	4905	0	2)	0	2)													
	40	0	0	0	0	2)	2)	2)	0	0	0	0	2)	0	2)													
10	Static	8700	6960	0	0	2)	2)	2)	8700	5800	8700	0	2)	8700	2)	11.00 R 20												
	1	7540	6090	0	0	2)	2)	2)	6670	5800	7540	0	2)	7540	2)													
	5	7540	6090	0	0	2)	2)	2)	6670	5800	7540	0	2)	7540	2)													
	10	7540	6090	0	0	2)	2)	2)	6670	5800	7540	0	2)	6090	2)													
	20	7540	5800	0	0	2)	2)	2)	6380	5800	5800	0	2)	5800	2)													
	25	7540	5800	0	0	2)	2)	2)	5800	5800	5800	0	2)	5800	2)													
	35	7250	5365	0	0	2)	2)	2)	5365	5365	5365	0	2)	0	2)													
	40	0	0	0	0	2)	2)	2)	0	0	0	0	2)	0	2)													
10	Static	10650	8520	0	0	2)	9230	2)	10650	7100	10650	0	2)	2)	2)	12.00 R 20												
	1	9230	7455	0	0	2)	9230	2)	8165	7100	9230	0	2)	2)	2)													
	5	9230	7455	0	0	2)	9230	2)	8165	7100	9230	0	2)	2)	2)													
	10	9230	7455	0	0	2)	9230	2)	8165	7100	9230	0	2)	2)	2)													
	20	9230	7100	0	0	2)	7990	2)	7810	7100	7100	0	2)	2)	2)													
	25	9230	7100	0	0	2)	7990	2)	7100	7100	7100	0	2)	2)	2)													
	35	8875	6570	0	0	2)	7100	2)	6570	6570	6570	0	2)	2)	2)													
	40	0	0	0	0	2)	7100	2)	0	0	0	0	2)	2)	2)													
10	Static	10650	8520	0	0	2)	9230	2)	10650	7100	10650	0	2)	2)	2)	12.00 R 20												
	1	9230	7455	0	0	2)	9230	2)	8165	7100	9230	0	2)	2)	2)													
	5	9230	7455	0	0	2)	9230	2)	8165	7100	9230	0	2)	2)	2)													
	10	9230	7455	0	0	2)	9230	2)	8165	7100	9230	0	2)	2)	2)													
	20	9230	7100	0	0	2)	7990	2)	7810	7100	7100	0	2)	2)	2)													
	25	9230	7100	0	0	2)	7990	2)	7100	7100	7100	0	2)	2)	2)													
	35	8875	6570	0	0	2)	7100	2)	6570	6570	6570	0	2)	2)	2)													
	40	0	0	0	0	2)	7100	2)	0	0	0	0	2)	2)	2)													

Technical Data Industrial Radial Tires

Size range, specifications and tire load capacities

Tire									Tire dimensions [mm]					
Size	Pattern	Tire Type	LI	SSY	Rim	Tube	Flap	TSR *	Article approximate data					
									Tread depth	Width	Outer dia.	Static ¹⁾ rad.	Rolling ²⁾ circ.	Min. Dual Spacing
12.00 R 20	ContiRV20	TL	176	A5	8.5 - 20	11.00 / 12.00-20 -	B 230-20 rein. -	TSR 20* Radial TL 20 -	36.0	311	1140	515	3487	379
365/80 R 20	TerminalMaster AP	TL	175	A5	10.00 V x 20	- / - -	- / - -	- / - -	15.8	348	1092	490	3308	- / -
280/75 R22.5	TerminalMaster	TL	168	A8	8.25 (7.50)	- -	- -	- -	29.5	279	995	450	3000	353
300/80 R22.5	Terminal Transport	TL	172	A8	9.00 (8.25)	- -	- -	- -	17.0	307	1054	477	3169	384
310/80 R22.5	TerminalMaster	TL	175	A8	9.00 (8.25)	- -	- -	- -	30.0	310	1084	487	3268	391
310/80 R22.5	TerminalMaster	TL	175	A8	9.00 (8.25)	- -	- -	- -	24.0	309	1070	482	3217	391

*) Use only in combination with tires compatible with Continental TSR system

1) At reference load.

2) Please contact Continental Technical Customer Center or Sales department for further details.

Inflation Pressure [bar]	Application	Reach Stackers, Counterbalanced Lift Trucks, Loaded Container Handlers, Empty Container Handlers		Rubber Tire Gantry Crane	Straddle/Shuttle Carriers	Ro-Ro Terminal Tractors	Terminal Tractors and Trailers	Automated Guided Vehicles (AGVs)	Sider Loader (Fork lift/Reach stacker)	Towbar Airport Tractor	Towbarless airport tractor	Small Ground Support Airport Tractor	Hot slag transporter	Heavy lift transport	Other vehicles	Please consult Continental	Size										
		Load Wheel	Steer Wheel																								
		Cycle Length (one way) km	1,6															0,6	2,5	2,5	1,6	1,6	7,0	7,0	2,0	3,0	10,0
		Max. laden speed (km/h)	25															8	35	20	40	25	30	32	32	30	15
Cyclic Load	Yes	Yes	Yes	Yes	Yes	Yes	Yes	Yes	No	Yes	No	Yes	No														
	Speed	Load[kg]																									
10	Static	10650	8520	0	0	2)	9230	2)	10650	7100	10650	0	2)	2)	2)	12.00 R 20											
	1	9230	7455	0	0	2)	9230	2)	8165	7100	9230	0	2)	2)	2)												
	5	9230	7455	0	0	2)	9230	2)	8165	7100	9230	0	2)	2)	2)												
	10	9230	7455	0	0	2)	9230	2)	8165	7100	9230	0	2)	2)	2)												
	20	9230	7100	0	0	2)	7990	2)	7810	7100	7100	0	2)	2)	2)												
	25	9230	7100	0	0	2)	7990	2)	7100	7100	7100	0	2)	2)	2)												
	35	8875	6570	0	0	2)	7100	2)	6570	6570	6570	0	2)	2)	2)												
	40	0	0	0	0	2)	7100	2)	0	0	0	0	2)	2)	2)												
50	0	0	0	0	2)	0	2)	0	0	0	0	2)	2)	2)													
10	Static	0	0	0	0	0	0	0	0	6900	10350	0	0	0	2)	365/80 R 20											
	1	0	0	0	0	0	0	0	0	6900	8970	0	0	0	2)												
	5	0	0	0	0	0	0	0	0	6900	8970	0	0	0	2)												
	10	0	0	0	0	0	0	0	0	6900	8970	0	0	0	2)												
	20	0	0	0	0	0	0	0	0	6900	6900	0	0	0	2)												
	25	0	0	0	0	0	0	0	0	6900	6900	0	0	0	2)												
	35	0	0	0	0	0	0	0	0	6385	6385	0	0	0	2)												
	40	0	0	0	0	0	0	0	0	0	0	0	0	0	2)												
50	0	0	0	0	0	0	0	0	0	0	0	0	0	2)													
10	Static	8400	6720	0	0	7280	7280	8400	8400	5600	8400	5600	8400	8400	8400	280/75 R22.5											
	1	7280	5880	0	0	7280	7280	7280	6440	5600	7280	5600	7280	7280	7280												
	5	7280	5880	0	0	7280	7280	7280	6440	5600	7280	5600	7280	7280	7280												
	10	7280	5880	0	0	7280	7280	7280	6440	5600	7280	5600	7280	5880	7280												
	20	7280	5600	0	0	6300	6300	7280	6160	5600	5600	5600	5600	5600	5600												
	25	7280	5600	0	0	6300	6300	7280	5600	5600	5600	5600	5600	5600	5600												
	35	7000	5180	0	0	5600	5600	0	5180	5180	5180	5180	5180	0	5180												
	40	0	0	0	0	5600	5600	0	0	0	0	0	0	0	4985												
50	0	0	0	0	0	0	0	0	0	0	0	0	0	4705													
10	Static	9450	7560	0	0	8190	8190	9450	9450	6300	9450	6300	9450	9450	9450	300/80 R22.5											
	1	8190	6615	0	0	8190	8190	8190	7245	6300	8190	6300	8190	8190	8190												
	5	8190	6615	0	0	8190	8190	8190	7245	6300	8190	6300	8190	8190	8190												
	10	8190	6615	0	0	8190	8190	8190	7245	6300	8190	6300	8190	6615	8190												
	20	8190	6300	0	0	7090	7090	8190	6930	6300	6300	6300	6300	6300	6300												
	25	8190	6300	0	0	7090	7090	8190	6300	6300	6300	6300	6300	6300	6300												
	35	7875	5830	0	0	6300	6300	0	5830	5830	5830	5830	5830	0	5830												
	40	0	0	0	0	6300	6300	0	0	0	0	0	0	0	5605												
50	0	0	0	0	0	0	0	0	0	0	0	0	0	5290													
10	Static	10350	8280	0	0	8970	8970	10350	10350	6900	10350	6900	10350	10350	10350	310/80 R22.5											
	1	8970	7245	0	0	8970	8970	8970	7935	6900	8970	6900	8970	8970	8970												
	5	8970	7245	0	0	8970	8970	8970	7935	6900	8970	6900	8970	8970	8970												
	10	8970	7245	0	0	8970	8970	8970	7935	6900	8970	6900	8970	7245	8970												
	20	8970	6900	0	0	7765	7765	8970	7590	6900	6900	6900	6900	6900	6900												
	25	8970	6900	0	0	7765	7765	8970	6900	6900	6900	6900	6900	6900	6900												
	35	8625	6385	0	0	6900	6900	0	6385	6385	6385	6385	6385	0	6385												
	40	0	0	0	0	6900	6900	0	0	0	0	0	0	0	6140												
50	0	0	0	0	0	0	0	0	0	0	0	0	0	5795													
10	Static	10350	8280	0	0	8970	8970	10350	10350	6900	10350	6900	10350	10350	10350	310/80 R22.5											
	1	8970	7245	0	0	8970	8970	8970	7935	6900	8970	6900	8970	8970	8970												
	5	8970	7245	0	0	8970	8970	8970	7935	6900	8970	6900	8970	8970	8970												
	10	8970	7245	0	0	8970	8970	8970	7935	6900	8970	6900	8970	7245	8970												
	20	8970	6900	0	0	7765	7765	8970	7590	6900	6900	6900	6900	6900	6900												
	25	8970	6900	0	0	7765	7765	8970	6900	6900	6900	6900	6900	6900	6900												
	35	8625	6385	0	0	6900	6900	0	6385	6385	6385	6385	6385	0	6385												
	40	0	0	0	0	6900	6900	0	0	0	0	0	0	0	6140												
50	0	0	0	0	0	0	0	0	0	0	0	0	0	5795													

Technical Data Industrial Radial Tires

Size range, specifications and tire load capacities

Tire									Tire dimensions [mm]					
Size	Pattern	Tire Type	LI	SSY	Rim	Tube	Flap	TSR *	Article approximate data					
									Tread depth	Width	Outer dia.	Static rad. ¹⁾	Rolling ²⁾ circ.	Min. Dual Spacing
310/80 R22.5	TerminalMaster	TL	175	A8	9.00 (8.25) x 22.5	-- / --- .	-- / -- .	-- / -- .	30.0	310	1084	487	3268	391

*) Use only in combination with tires compatible with Continental TSR system

1) At reference load.

2) Please contact Continental Technical Customer Center or Sales department for clarification.

Inflation Pressure [bar]	Application	Reach Stackers, Counterbalanced Lift Trucks, Loaded Container Handlers, Empty Container Handlers		Rubber Tire Gantry Crane	Straddle/Shuttle Carriers	Ro-Ro Terminal Tractors	Terminal Tractors and Trailers	Automated Guided Vehicles (AGVs)	Sider Loader (Fork lift/Reach stacker)	Towbar Airport Tractor	Towbarless airport tractor	Small Ground Support Airport Tractor	Hot slag transporter	Heavy lift transport	Other vehicles	Size	
		Load Wheel	Steer Wheel														
	Cycle Length (one way) km	1,6		0,6	2,5	2,5	2,5	1,6	1,6	7,0	7,0	2,0	3,0	10,0		Please consult Continental	
	Max. laden speed (km/h)	25		8	35	20	40	25	30	32	32	30	15	3			
	Cyclic Load	Yes		Yes	Yes	Yes	Yes	Yes	Yes	No	Yes	No	Yes	No			
	Speed	Load[kg]															
10	Static	10350	8280	0	0	8970	8970	10350	10350	6900	10350	6900	10350	10350	10350	310/80 R22.5	
	1	8970	7245	0	0	8970	8970	8970	7935	6900	8970	6900	8970	8970	8970		
	5	8970	7245	0	0	8970	8970	8970	7935	6900	8970	6900	8970	8970	8970		
	10	8970	7245	0	0	8970	8970	8970	7935	6900	8970	6900	8970	7245	8970		
	20	8970	6900	0	0	7765	7765	8970	7590	6900	6900	6900	6900	6900	6900		
	25	8970	6900	0	0	7765	7765	8970	6900	6900	6900	6900	6900	6900	6900		
	35	8625	6385	0	0	6900	6900	0	6385	6385	6385	6385	6385	6385	0		6385
	40	0	0	0	0	6900	6900	0	0	0	0	0	0	0	0		6140
50	0	0	0	0	0	0	0	0	0	0	0	0	0	0	5795		

Industrial Cross-ply Pneumatic Tires



IC40



-
- › High loading capability
 - › High tire stability
 - › High damage resistance
-



IC10/12



-
- › Protection from punctures
 - › Good driving comfort
 - › Good suspension
-



Technical Data Industrial Crossply Tires

Size range, specifications and tire load capacities

Tire									Tire dimensions [mm]					Min. Dual Spacing
Size	Pattern	Tire Type	LI	SSY	PR	Rim	Tube	Flap	Article approximate data					
									Tread depth	Width	Outer dia.	Static ¹⁾ rad.	Rolling ¹⁾ circ.	
3.00 - 4	IC10	TT	51	A5	4	2.10 - 4	S 3.00 - 4 F	-	4.5	83	248	112	746	98
3.00 - 4	IC35	TT	51	A5	4	2.10 - 4	3.00 - 4	-	1.5	82	252	114	757	98
4.00 - 4	IC10	TT	77	A5	6	2.50 C-4	S 4.00 - 4 F	-	5.2	107	312	140	938	128
4.00 - 8	IC10	TT	97	A5	10	3.00 D-8	S 4.00 - 8 F	B 85 - 8	5.5	114	418	192	1255	134
15 X 4 1/2 - 8	IC36	TT	100	A5	12	3.00 D-8	15x4 1/2 - 8	B 85 - 8	5.2	123	378	173	1156	137 / (140)
5.00 - 8	IC10	TT	106	A5	8	3.00 D-8	S 5.00 - 8 F s	B 85 - 8 s	6.5	132	469	214	1356	158

1) At reference load.

2) Other vehicles: platform trucks, trailers, tractive units, straddle carriers, fork lifts without counterweight, terminal tractors etc.

3) For tire used with straddle carriers and straddle fork lifts with max. speed 25 km/h and 35 km/h the load capacities of steered wheels on fork lifts have to be used.

Inflation Pressure [bar]	Application	Reach Stackers, Counterbalanced Lift Trucks, Loaded Container Handlers, Empty Container Handlers		Rubber Tire Gantry Crane	Straddle/Shuttle Carriers	Ro-Ro Terminal Tractors	Terminal Tractors and Trailers	Automated Guided Vehicles (AGVs)	Sider Loader (Fork lift/Reach stacker)	Towbar Airport Tractor	Towbarless airport tractor	Small Ground Support Airport Tractor	Hot slag transporter	Heavy lift transport	Other vehicles	Size	
		Load Wheel	Steer Wheel														
	Cycle Length (one way) km	1,6		0,6	2,5	2,5	20	40	1,6	1,6	7,0	7,0	2,0	3,0	10,0		Please consult Continental
	Max. laden speed (km/h)	25		8	35	20	40	25	30	32	32	30	15	3			
Cyclic Load	Yes		Yes	Yes	Yes	Yes	Yes	Yes	No	Yes	No	Yes	No				
Speed		Load[kg]														Size	
6,75	Static	0	0	0	0	0	0	0	0	0	0	0	195	0	0	2)	3.00 - 4
	1	0	0	0	0	0	0	0	0	0	0	0	195	0	0	2)	
	5	0	0	0	0	0	0	0	0	0	0	0	195	0	0	2)	
	10	0	0	0	0	0	0	0	0	0	0	0	195	0	0	2)	
	20	0	0	0	0	0	0	0	0	0	0	0	195	0	0	2)	
	25	0	0	0	0	0	0	0	0	0	0	0	195	0	0	2)	
	35	0	0	0	0	0	0	0	0	0	0	0	185	0	0	2)	
	40	0	0	0	0	0	0	0	0	0	0	0	0	0	0	2)	
6,75	Static	0	0	0	0	0	0	0	0	0	0	0	195	0	0	2)	3.00 - 4
	1	0	0	0	0	0	0	0	0	0	0	0	195	0	0	2)	
	5	0	0	0	0	0	0	0	0	0	0	0	195	0	0	2)	
	10	0	0	0	0	0	0	0	0	0	0	0	195	0	0	2)	
	20	0	0	0	0	0	0	0	0	0	0	0	195	0	0	2)	
	25	0	0	0	0	0	0	0	0	0	0	0	195	0	0	2)	
	35	0	0	0	0	0	0	0	0	0	0	0	185	0	0	2)	
	40	0	0	0	0	0	0	0	0	0	0	0	0	0	0	2)	
8	Static	0	0	0	0	0	0	0	0	0	0	0	415	0	0	2)	4.00 - 4
	1	0	0	0	0	0	0	0	0	0	0	0	415	0	0	2)	
	5	0	0	0	0	0	0	0	0	0	0	0	415	0	0	2)	
	10	0	0	0	0	0	0	0	0	0	0	0	415	0	0	2)	
	20	0	0	0	0	0	0	0	0	0	0	0	415	0	0	2)	
	25	0	0	0	0	0	0	0	0	0	0	0	415	0	0	2)	
	35	0	0	0	0	0	0	0	0	0	0	0	385	0	0	2)	
	40	0	0	0	0	0	0	0	0	0	0	0	0	0	0	2)	
10	Static	0	0	0	0	0	0	0	0	0	0	0	730	0	0	2)	4.00 - 8
	1	0	0	0	0	0	0	0	0	0	0	0	730	0	0	2)	
	5	0	0	0	0	0	0	0	0	0	0	0	730	0	0	2)	
	10	0	0	0	0	0	0	0	0	0	0	0	730	0	0	2)	
	20	0	0	0	0	0	0	0	0	0	0	0	730	0	0	2)	
	25	0	0	0	0	0	0	0	0	0	0	0	730	0	0	2)	
	35	0	0	0	0	0	0	0	0	0	0	0	680	0	0	2)	
	40	0	0	0	0	0	0	0	0	0	0	0	0	0	0	2)	
10	Static	1200	960	0	0	0	0	0	0	0	0	0	800	0	0	2)	15 X 4 1/2 - 8
	1	1040	840	0	0	0	0	0	0	0	0	0	800	0	0	2)	
	5	1040	840	0	0	0	0	0	0	0	0	0	800	0	0	2)	
	10	1040	840	0	0	0	0	0	0	0	0	0	800	0	0	2)	
	20	1040	800	0	0	0	0	0	0	0	0	0	800	0	0	2)	
	25	1040	800	0	0	0	0	0	0	0	0	0	800	0	0	2)	
	35	1000	740	0	0	0	0	0	0	0	0	0	740	0	0	2)	
	40	0	0	0	0	0	0	0	0	0	0	0	0	0	0	2)	
8,25	Static	1425	1140	0	0	0	0	0	0	0	2)	0	950	0	0	2)	5.00 - 8
	1	1235	1000	0	0	0	0	0	0	0	2)	0	950	0	0	2)	
	5	1235	1000	0	0	0	0	0	0	0	2)	0	950	0	0	2)	
	10	1235	1000	0	0	0	0	0	0	0	2)	0	950	0	0	2)	
	20	1235	950	0	0	0	0	0	0	0	2)	0	950	0	0	2)	
	25	1235	950	0	0	0	0	0	0	0	2)	0	950	0	0	2)	
	35	1190	880	0	0	0	0	0	0	0	2)	0	880	0	0	2)	
	40	0	0	0	0	0	0	0	0	0	2)	0	0	0	0	2)	

Technical Data Industrial Crossply Tires

Size range, specifications and tire load capacities

Tire									Tire dimensions [mm]					Min. Dual Spacing
Size	Pattern	Tire Type	LI	SSY	PR	Rim	Tube	Flap	Article approximate data					
									Tread depth	Width	Outer dia.	Static ¹⁾ rad.	Rolling ¹⁾ circ.	
5.00 - 8	IC40	TT	106	A5	8	3.00 D-8	S 5.00-8 f s	B 85-8 s	17.5	136	475	224	1444	158
16 X 6 - 8	IC12	TT	113	A5	16	4.33 R-8	S 16x6 - 8 F	B 115 - 8	7.3	143	422	192	1288	175
18 X 7 - 8	IC12	TT	125	A5	16	4.33 R-8	S 18x7 - 8 F	B 115 - 8	7.3	163	461	206	1408	199
18 X 7 - 8	IC40	TT	125	A5	16	4.33 R-8	S 18x7 - 8 F	B 115 - 8	16.5	172	474	219	1445	199
6.00 - 9	IC10	TT	121	A5	12	4.00 E-9	S 6.00 - 9 F	B 100 - 9	10.5	158	539	245	1620	192
6.00 - 9	IC40	TT	121	A5	12	4.00 E-9	S 6.00-9 F / T	B 100 - 9	19.0	160	542	253	1674	192

1) At reference load.

2) Other vehicles: platform trucks, trailers, tractive units, straddle carriers, fork lifts without counterweight, terminal tractors etc.

3) For tire used with straddle carriers and straddle fork lifts with max. speed 25 km/h and 35 km/h the load capacities of steered wheels on fork lifts have to be used.

Inflation Pressure [bar]	Application	Reach Stackers, Counterbalanced Lift Trucks, Loaded Container Handlers, Empty Container Handlers		Rubber Tire Gantry Crane	Straddle/Shuttle Carriers	Ro-Ro Terminal Tractors	Terminal Tractors and Trailers	Automated Guided Vehicles (AGVs)	Sider Loader (Fork lift/Reach stacker)	Towbar Airport Tractor	Towbarless airport tractor	Small Ground Support Airport Tractor	Hot slag transporter	Heavy lift transport	Other vehicles	Size
		Load Wheel	Steer Wheel													
	Cycle Length (one way) km	1,6		0,6	2,5	2,5	2,5	1,6	1,6	7,0	7,0	2,0	3,0	10,0	Please consult Continental	
	Max. laden speed (km/h)	25		8	35	20	40	25	30	32	32	30	15	3		
Cyclic Load	Yes		Yes	Yes	Yes	Yes	Yes	Yes	No	Yes	No	Yes	No			
Speed		Load[kg]													Size	
8,25	Static	1425	1140	0	0	0	0	0	0	0	2)	950	0	0		2)
	1	1235	1000	0	0	0	0	0	0	0	2)	950	0	0	2)	
	5	1235	1000	0	0	0	0	0	0	0	2)	950	0	0	2)	
	10	1235	1000	0	0	0	0	0	0	0	2)	950	0	0	2)	
	20	1235	950	0	0	0	0	0	0	0	2)	950	0	0	2)	
	25	1235	950	0	0	0	0	0	0	0	2)	950	0	0	2)	
	35	1190	880	0	0	0	0	0	0	0	2)	880	0	0	2)	
	40	0	0	0	0	0	0	0	0	0	2)	0	0	0	2)	
50	0	0	0	0	0	0	0	0	0	2)	0	0	0	2)		
10	Static	1725	1380	0	0	0	0	0	0	0	2)	1150	0	0	2)	16 X 6 - 8
	1	1495	1210	0	0	0	0	0	0	0	2)	1150	0	0	2)	
	5	1495	1210	0	0	0	0	0	0	0	2)	1150	0	0	2)	
	10	1495	1210	0	0	0	0	0	0	0	2)	1150	0	0	2)	
	20	1495	1150	0	0	0	0	0	0	0	2)	1150	0	0	2)	
	25	1495	1150	0	0	0	0	0	0	0	2)	1150	0	0	2)	
	35	1440	1065	0	0	0	0	0	0	0	2)	1065	0	0	2)	
	40	0	0	0	0	0	0	0	0	0	2)	0	0	0	2)	
50	0	0	0	0	0	0	0	0	0	2)	0	0	0	2)		
10	Static	2475	1980	0	0	0	0	0	0	0	2)	1650	0	0	2)	18 X 7 - 8
	1	2145	1735	0	0	0	0	0	0	0	2)	1650	0	0	2)	
	5	2145	1735	0	0	0	0	0	0	0	2)	1650	0	0	2)	
	10	2145	1735	0	0	0	0	0	0	0	2)	1650	0	0	2)	
	20	2145	1650	0	0	0	0	0	0	0	2)	1650	0	0	2)	
	25	2145	1650	0	0	0	0	0	0	0	2)	1650	0	0	2)	
	35	2065	1530	0	0	0	0	0	0	0	2)	1530	0	0	2)	
	40	0	0	0	0	0	0	0	0	0	2)	0	0	0	2)	
50	0	0	0	0	0	0	0	0	0	2)	0	0	0	2)		
10	Static	2475	1980	0	0	0	0	0	0	0	2)	1650	0	0	2)	18 X 7 - 8
	1	2145	1735	0	0	0	0	0	0	0	2)	1650	0	0	2)	
	5	2145	1735	0	0	0	0	0	0	0	2)	1650	0	0	2)	
	10	2145	1735	0	0	0	0	0	0	0	2)	1650	0	0	2)	
	20	2145	1650	0	0	0	0	0	0	0	2)	1650	0	0	2)	
	25	2145	1650	0	0	0	0	0	0	0	2)	1650	0	0	2)	
	35	2065	1530	0	0	0	0	0	0	0	2)	1530	0	0	2)	
	40	0	0	0	0	0	0	0	0	0	2)	0	0	0	2)	
50	0	0	0	0	0	0	0	0	0	2)	0	0	0	2)		
10	Static	2175	1740	0	0	0	0	0	0	0	2)	1450	0	0	2)	6.00 - 9
	1	1885	1525	0	0	0	0	0	0	0	2)	1450	0	0	2)	
	5	1885	1525	0	0	0	0	0	0	0	2)	1450	0	0	2)	
	10	1885	1525	0	0	0	0	0	0	0	2)	1450	0	0	2)	
	20	1885	1450	0	0	0	0	0	0	0	2)	1450	0	0	2)	
	25	1885	1450	0	0	0	0	0	0	0	2)	1450	0	0	2)	
	35	1815	1345	0	0	0	0	0	0	0	2)	1345	0	0	2)	
	40	0	0	0	0	0	0	0	0	0	2)	0	0	0	2)	
50	0	0	0	0	0	0	0	0	0	2)	0	0	0	2)		
10	Static	2175	1740	0	0	0	0	0	0	0	2)	1450	0	0	2)	6.00 - 9
	1	1885	1525	0	0	0	0	0	0	0	2)	1450	0	0	2)	
	5	1885	1525	0	0	0	0	0	0	0	2)	1450	0	0	2)	
	10	1885	1525	0	0	0	0	0	0	0	2)	1450	0	0	2)	
	20	1885	1450	0	0	0	0	0	0	0	2)	1450	0	0	2)	
	25	1885	1450	0	0	0	0	0	0	0	2)	1450	0	0	2)	
	35	1815	1345	0	0	0	0	0	0	0	2)	1345	0	0	2)	
	40	0	0	0	0	0	0	0	0	0	2)	0	0	0	2)	
50	0	0	0	0	0	0	0	0	0	2)	0	0	0	2)		

Technical Data Industrial Crossply Tires

Size range, specifications and tire load capacities

Tire									Tire dimensions [mm]					Min. Dual Spacing
Size	Pattern	Tire Type	LI	SSY	PR	Rim	Tube	Flap	Article approximate data					
									Tread depth	Width	Outer dia.	Static ¹⁾ rad.	Rolling ¹⁾ circ.	
6.00 - 9	IC40	TT	121	A5	12	4.00 E-9	6.00-9 F / T	B100-9	19.0	169	547	255	1674	195
21 X 8 - 9	IC40	TT	134	A5	16	6.00 E-9	S 6.00-9; 21x8-9 T	B 150 - 9	19.4	195	533	244	1627	230
6.50 - 10	IC10	TT	128	A5	14	5.00 F-10	S 6.50 - 10 F	B 130 - 10	10.6	174	581	262	1746	212 / (218)
6.50 - 10	IC40	TT	128	A5	14	5.00 F-10	S 6.50 - 10 F s	B 130 - 10 s	23.5	181	594	274	1830	212 / (218)
6.50 - 10	IC40	TT	128	A5	14	5.00 F-10 / 5.50 F-10	S 6.50 -10 F / F s	B 130 - 10 (s)	23.5	190	602	279	1830	212 / 218
7.50 - 10	IC10	TT	133	A5	12	5.50 F-10	S 7.50 - 10 F s	B 130 - 10 s	12.0	204	616	280	1852	248

1) At reference load.

2) Other vehicles: platform trucks, trailers, tractive units, straddle carriers, fork lifts without counterweight, terminal tractors etc.

3) For tire used with straddle carriers and straddle fork lifts with max. speed 25 km/h and 35 km/h the load capacities of steered wheels on fork lifts have to be used.

Inflation Pressure [bar]	Application	Reach Stackers, Counterbalanced Lift Trucks, Loaded Container Handlers, Empty Container Handlers		Rubber Tire Gantry Crane	Straddle/Shuttle Carriers	Ro-Ro Terminal Tractors	Terminal Tractors and Trailers	Automated Guided Vehicles (AGVs)	Sider Loader (Fork lift/Reach stacker)	Towbar Airport Tractor	Towbarless airport tractor	Small Ground Support Airport Tractor	Hot slag transporter	Heavy lift transport	Other vehicles	Size	
		Load Wheel	Steer Wheel														
	Cycle Length (one way) km	1,6		0,6	2,5	2,5	2,5	1,6	1,6	7,0	7,0	2,0	3,0	10,0			Please consult Continental
	Max. laden speed (km/h)	25		8	35	20	40	25	30	32	32	30	15	3			
Cyclic Load	Yes		Yes	Yes	Yes	Yes	Yes	Yes	No	Yes	No	Yes	No				
Speed		Load[kg]														Size	
10	Static	2175	1740	0	0	0	0	0	0	0	2)	1450	0	0	2)	6.00 - 9	
	1	1885	1525	0	0	0	0	0	0	0	2)	1450	0	0	2)		
	5	1885	1525	0	0	0	0	0	0	0	2)	1450	0	0	2)		
	10	1885	1525	0	0	0	0	0	0	0	2)	1450	0	0	2)		
	20	1885	1450	0	0	0	0	0	0	0	2)	1450	0	0	2)		
	25	1885	1450	0	0	0	0	0	0	0	2)	1450	0	0	2)		
	35	1815	1345	0	0	0	0	0	0	0	2)	1345	0	0	2)		
	40	0	0	0	0	0	0	0	0	0	2)	0	0	0	2)		
10,0	Static	3180	2545	0	0	0	0	0	0	0	2)	2120	0	0	2)	21 X 8 - 9	
	1	2760	2230	0	0	0	0	0	0	0	2)	2120	0	0	2)		
	5	2760	2230	0	0	0	0	0	0	0	2)	2120	0	0	2)		
	10	2760	2230	0	0	0	0	0	0	0	2)	2120	0	0	2)		
	20	2760	2120	0	0	0	0	0	0	0	2)	2120	0	0	2)		
	25	2760	2120	0	0	0	0	0	0	0	2)	2120	0	0	2)		
	35	2650	1965	0	0	0	0	0	0	0	2)	1965	0	0	2)		
	40	0	0	0	0	0	0	0	0	0	2)	0	0	0	2)		
10	Static	2700	2160	0	0	0	0	0	0	0	2)	1800	0	0	2)	6.50 - 10	
	1	2340	1890	0	0	0	0	0	0	0	2)	1800	0	0	2)		
	5	2340	1890	0	0	0	0	0	0	0	2)	1800	0	0	2)		
	10	2340	1890	0	0	0	0	0	0	0	2)	1800	0	0	2)		
	20	2340	1800	0	0	0	0	0	0	0	2)	1800	0	0	2)		
	25	2340	1800	0	0	0	0	0	0	0	2)	1800	0	0	2)		
	35	2250	1665	0	0	0	0	0	0	0	2)	1665	0	0	2)		
	40	0	0	0	0	0	0	0	0	0	2)	0	0	0	2)		
10	Static	2700	2160	0	0	0	0	0	0	0	2)	1800	0	0	2)	6.50 - 10	
	1	2340	1890	0	0	0	0	0	0	0	2)	1800	0	0	2)		
	5	2340	1890	0	0	0	0	0	0	0	2)	1800	0	0	2)		
	10	2340	1890	0	0	0	0	0	0	0	2)	1800	0	0	2)		
	20	2340	1800	0	0	0	0	0	0	0	2)	1800	0	0	2)		
	25	2340	1800	0	0	0	0	0	0	0	2)	1800	0	0	2)		
	35	2250	1665	0	0	0	0	0	0	0	2)	1665	0	0	2)		
	40	0	0	0	0	0	0	0	0	0	2)	0	0	0	2)		
10	Static	2700	2160	0	0	0	0	0	0	0	2)	1800	0	0	2)	6.50 - 10	
	1	2340	1890	0	0	0	0	0	0	0	2)	1800	0	0	2)		
	5	2340	1890	0	0	0	0	0	0	0	2)	1800	0	0	2)		
	10	2340	1890	0	0	0	0	0	0	0	2)	1800	0	0	2)		
	20	2340	1800	0	0	0	0	0	0	0	2)	1800	0	0	2)		
	25	2340	1800	0	0	0	0	0	0	0	2)	1800	0	0	2)		
	35	2250	1665	0	0	0	0	0	0	0	2)	1665	0	0	2)		
	40	0	0	0	0	0	0	0	0	0	2)	0	0	0	2)		
8	Static	3090	2475	0	0	0	0	0	0	0	2)	2060	0	0	2)	7.50 - 10	
	1	2680	2165	0	0	0	0	0	0	0	2)	2060	0	0	2)		
	5	2680	2165	0	0	0	0	0	0	0	2)	2060	0	0	2)		
	10	2680	2165	0	0	0	0	0	0	0	2)	2060	0	0	2)		
	20	2680	2060	0	0	0	0	0	0	0	2)	2060	0	0	2)		
	25	2680	2060	0	0	0	0	0	0	0	2)	2060	0	0	2)		
	35	2575	1910	0	0	0	0	0	0	0	2)	1910	0	0	2)		
	40	0	0	0	0	0	0	0	0	0	2)	0	0	0	2)		
50	0	0	0	0	0	0	0	0	0	2)	0	0	0	2)			

Technical Data Industrial Crossply Tires

Size range, specifications and tire load capacities

Tire									Tire dimensions [mm]					
Size	Pattern	Tire Type	LI	SSY	PR	Rim	Tube	Flap	Article approximate data					Min. Dual Spacing
									Tread depth	Width	Outer dia.	Static ¹⁾ rad.	Rolling ¹⁾ circ.	
23 X 9 - 10	IC40	TT	142	A5	20	6.50 F-10	S 23x9 - 10 F	B 180 - 10	21.0	225	600	277	1811	259
7.00 - 12	IC10	TT	134	A5	14	5.00 S-12	S 7.00-12 F	B 130-12	11.5	190	667	302	2013	230
7.00 - 12	IC10	TT	136	A5	16	5.00 S-12	S 7.00-12 F	B 130-12	11.5	190	667	302	2013	230
7.00 - 12	IC40	TT	134	A5	14	5.00 S-12	S 7.00-12 F	B 130-12	21.5	196	669	313	2067	230
7.00 - 12	IC40	TT	136	A5	16	5.00 S-12	S 7.00-12 F	B 130-12	21.5	196	669	313	2067	230
27 X 10 - 12	IC30	TT	143	A5	14	8.00 G-12	27x10 - 12	B 220 - 12	14.6	255	671	298	2051	293

1) At reference load.

2) Other vehicles: platform trucks, trailers, tractive units, straddle carriers, fork lifts without counterweight, terminal tractors etc.

3) For tire used with straddle carriers and straddle fork lifts with max. speed 25 km/h and 35 km/h the load capacities of steered wheels on fork lifts have to be used.

Inflation Pressure [bar]	Application	Reach Stackers, Counterbalanced Lift Trucks, Loaded Container Handlers, Empty Container Handlers		Rubber Tire Gantry Crane	Straddle/Shuttle Carriers	Ro-Ro Terminal Tractors	Terminal Tractors and Trailers	Automated Guided Vehicles (AGVs)	Sider Loader (Fork lift/Reach stacker)	Towbar Airport Tractor	Towbarless airport tractor	Small Ground Support Airport Tractor	Hot slag transporter	Heavy lift transport	Other vehicles	Please consult Continental	Size
		Load Wheel	Steer Wheel														
	Cycle Length (one way) km	1,6		0,6	2,5	2,5	2,5	1,6	1,6	7,0	7,0	2,0	3,0	10,0			
	Max. laden speed (km/h)	25		8	35	20	40	25	30	32	32	30	15	3			
	Cyclic Load	Yes		Yes	Yes	Yes	Yes	Yes	Yes	No	Yes	No	Yes	No			
	Speed	Load[kg]															
10	Static	3975	3180	0	0	0	0	0	0	0	2)	2650	0	0	2)	23 X 9 - 10	
	1	3445	2785	0	0	0	0	0	0	0	2)	2650	0	0	2)		
	5	3445	2785	0	0	0	0	0	0	0	2)	2650	0	0	2)		
	10	3445	2785	0	0	0	0	0	0	0	2)	2650	0	0	2)		
	20	3445	2650	0	0	0	0	0	0	0	2)	2650	0	0	2)		
	25	3445	2650	0	0	0	0	0	0	0	2)	2650	0	0	2)		
	35	3315	2455	0	0	0	0	0	0	0	2)	2455	0	0	2)		
	40	0	0	0	0	0	0	0	0	0	2)	0	0	0	2)		
9	Static	3180	2545	0	0	0	0	0	3180	0	2)	2120	0	0	2)	7.00 - 12	
	1	2760	2230	0	0	0	0	0	2440	0	2)	2120	0	0	2)		
	5	2760	2230	0	0	0	0	0	2440	0	2)	2120	0	0	2)		
	10	2760	2230	0	0	0	0	0	2440	0	2)	2120	0	0	2)		
	20	2760	2120	0	0	0	0	0	2335	0	2)	2120	0	0	2)		
	25	2760	2120	0	0	0	0	0	2120	0	2)	2120	0	0	2)		
	35	2650	1965	0	0	0	0	0	1965	0	2)	1965	0	0	2)		
	40	0	0	0	0	0	0	0	0	0	2)	0	0	0	2)		
10	Static	3360	2690	0	0	0	0	0	3360	0	2)	2240	0	0	2)	7.00 - 12	
	1	2915	2355	0	0	0	0	0	2580	0	2)	2240	0	0	2)		
	5	2915	2355	0	0	0	0	0	2580	0	2)	2240	0	0	2)		
	10	2915	2355	0	0	0	0	0	2580	0	2)	2240	0	0	2)		
	20	2915	2240	0	0	0	0	0	2465	0	2)	2240	0	0	2)		
	25	2915	2240	0	0	0	0	0	2240	0	2)	2240	0	0	2)		
	35	2800	2075	0	0	0	0	0	2075	0	2)	2075	0	0	2)		
	40	0	0	0	0	0	0	0	0	0	2)	0	0	0	2)		
9	Static	3180	2545	0	0	0	0	0	3180	0	2)	2120	0	0	2)	7.00 - 12	
	1	2760	2230	0	0	0	0	0	2440	0	2)	2120	0	0	2)		
	5	2760	2230	0	0	0	0	0	2440	0	2)	2120	0	0	2)		
	10	2760	2230	0	0	0	0	0	2440	0	2)	2120	0	0	2)		
	20	2760	2120	0	0	0	0	0	2335	0	2)	2120	0	0	2)		
	25	2760	2120	0	0	0	0	0	2120	0	2)	2120	0	0	2)		
	35	2650	1965	0	0	0	0	0	1965	0	2)	1965	0	0	2)		
	40	0	0	0	0	0	0	0	0	0	2)	0	0	0	2)		
10	Static	3360	2690	0	0	0	0	0	3360	0	2)	2240	0	0	2)	7.00 - 12	
	1	2915	2355	0	0	0	0	0	2580	0	2)	2240	0	0	2)		
	5	2915	2355	0	0	0	0	0	2580	0	2)	2240	0	0	2)		
	10	2915	2355	0	0	0	0	0	2580	0	2)	2240	0	0	2)		
	20	2915	2240	0	0	0	0	0	2465	0	2)	2240	0	0	2)		
	25	2915	2240	0	0	0	0	0	2240	0	2)	2240	0	0	2)		
	35	2800	2075	0	0	0	0	0	2075	0	2)	2075	0	0	2)		
	40	0	0	0	0	0	0	0	0	0	2)	0	0	0	2)		
7	Static	4090	3270	0	0	0	0	0	4090	0	0	2725	0	0	2)	27 X 10 - 12	
	1	3545	2865	0	0	0	0	0	3135	0	0	2725	0	0	2)		
	5	3545	2865	0	0	0	0	0	3135	0	0	2725	0	0	2)		
	10	3545	2865	0	0	0	0	0	3135	0	0	2725	0	0	2)		
	20	3545	2725	0	0	0	0	0	3000	0	0	2725	0	0	2)		
	25	3545	2725	0	0	0	0	0	2725	0	0	2725	0	0	2)		
	35	3410	2525	0	0	0	0	0	2525	0	0	2525	0	0	2)		
	40	0	0	0	0	0	0	0	0	0	0	0	0	0	2)		
50	0	0	0	0	0	0	0	0	0	0	0	0	0	2)			

Technical Data Industrial Crossply Tires

Size range, specifications and tire load capacities

Tire									Tire dimensions [mm]					
Size	Pattern	Tire Type	LI	SSY	PR	Rim	Tube	Flap	Article approximate data					
									Tread depth	Width	Outer dia.	Static ¹⁾ rad.	Rolling ¹⁾ circ.	Min. Dual Spacing
27 X 10 - 12	IC40	TT	143	A5	14	8.00 G-12	S 27x10 - 12 F s	B 220 - 12 s	24.3	243	685	319	2091	293
27 X 10 - 12	IC40	TT	152	A5	20	8.00 G-12	S 27x10 - 12 F s	B 220 - 12 s	24.3	243	685	319	2091	293
21 X 4	IC10	TT	98	A5	4	3.11 F-13	S 21x4 F	B 100 - 13	6.6	120	571	259	1718	145
23 X 5	IC10	TT	113	A5	6	3.75 P-13	S 23x5 F	B 100 - 13	8.3	154	633	288	1904	186
23 X 5	IC40	TT	113	A5	6	3.75 P-13	S 23x5 F	B 100 - 13	19.9	153	636	295	1965	186
25 X 6	IC10	TT	126	A5	8	3.75 P-13	S 25x6 F	B 100 - 13	10.1	166	674	304	2028	204

1) At reference load.

2) Other vehicles: platform trucks, trailers, tractive units, straddle carriers, fork lifts without counterweight, terminal tractors etc.

3) For tire used with straddle carriers and straddle fork lifts with max. speed 25 km/h and 35 km/h the load capacities of steered wheels on fork lifts have to be used.

Inflation Pressure [bar]	Application	Reach Stackers, Counterbalanced Lift Trucks, Loaded Container Handlers, Empty Container Handlers		Rubber Tire Gantry Crane	Straddle/Shuttle Carriers	Ro-Ro Terminal Tractors	Terminal Tractors and Trailers	Automated Guided Vehicles (AGVs)	Sider Loader (Fork lift/Reach stacker)	Towbar Airport Tractor	Towbarless airport tractor	Small Ground Support Airport Tractor	Hot slag transporter	Heavy lift transport	Other vehicles	Size
		Load Wheel	Steer Wheel													
	Cycle Length (one way) km	1,6		0,6	2,5	2,5	2,5	1,6	1,6	7,0	7,0	2,0	3,0	10,0		
	Max. laden speed (km/h)	25		8	35	20	40	25	30	32	32	30	15	3		
	Cyclic Load	Yes		Yes	Yes	Yes	Yes	Yes	Yes	No	Yes	No	Yes	No	Please consult Continental	
	Speed	Load[kg]														
7	Static	4090	3270	0	0	0	0	0	4090	2725	4090	2725	0	0	2)	27 X 10 - 12
	1	3545	2865	0	0	0	0	0	3135	2725	3545	2725	0	0	2)	
	5	3545	2865	0	0	0	0	0	3135	2725	3545	2725	0	0	2)	
	10	3545	2865	0	0	0	0	0	3135	2725	3545	2725	0	0	2)	
	20	3545	2725	0	0	0	0	0	3000	2725	2725	2725	0	0	2)	
	25	3545	2725	0	0	0	0	0	2725	2725	2725	2725	0	0	2)	
	35	3410	2525	0	0	0	0	0	2525	2525	2525	2525	0	0	2)	
	40	0	0	0	0	0	0	0	0	0	0	0	0	0	2)	
10	Static	5325	4260	0	0	0	0	0	5325	3550	5325	3550	0	0	2)	27 X 10 - 12
	1	4615	3730	0	0	0	0	0	4085	3550	4615	3550	0	0	2)	
	5	4615	3730	0	0	0	0	0	4085	3550	4615	3550	0	0	2)	
	10	4615	3730	0	0	0	0	0	4085	3550	4615	3550	0	0	2)	
	20	4615	3550	0	0	0	0	0	3905	3550	3550	3550	0	0	2)	
	25	4615	3550	0	0	0	0	0	3550	3550	3550	3550	0	0	2)	
	35	4440	3285	0	0	0	0	0	3285	3285	3285	3285	0	0	2)	
	40	0	0	0	0	0	0	0	0	0	0	0	0	0	2)	
4,75	Static	0	0	0	0	0	0	0	0	0	0	750	0	0	2)	21 X 4
	1	0	0	0	0	0	0	0	0	0	0	750	0	0	2)	
	5	0	0	0	0	0	0	0	0	0	0	750	0	0	2)	
	10	0	0	0	0	0	0	0	0	0	0	750	0	0	2)	
	20	0	0	0	0	0	0	0	0	0	0	750	0	0	2)	
	25	0	0	0	0	0	0	0	0	0	0	750	0	0	2)	
	35	0	0	0	0	0	0	0	0	0	0	695	0	0	2)	
	40	0	0	0	0	0	0	0	0	0	0	0	0	0	2)	
5,25	Static	0	0	0	0	0	0	0	0	0	0	1150	0	0	2)	23 X 5
	1	0	0	0	0	0	0	0	0	0	0	1150	0	0	2)	
	5	0	0	0	0	0	0	0	0	0	0	1150	0	0	2)	
	10	0	0	0	0	0	0	0	0	0	0	1150	0	0	2)	
	20	0	0	0	0	0	0	0	0	0	0	1150	0	0	2)	
	25	0	0	0	0	0	0	0	0	0	0	1150	0	0	2)	
	35	0	0	0	0	0	0	0	0	0	0	1065	0	0	2)	
	40	0	0	0	0	0	0	0	0	0	0	0	0	0	2)	
5,25	Static	0	0	0	0	0	0	0	0	0	0	1150	0	0	2)	23 X 5
	1	0	0	0	0	0	0	0	0	0	0	1150	0	0	2)	
	5	0	0	0	0	0	0	0	0	0	0	1150	0	0	2)	
	10	0	0	0	0	0	0	0	0	0	0	1150	0	0	2)	
	20	0	0	0	0	0	0	0	0	0	0	1150	0	0	2)	
	25	0	0	0	0	0	0	0	0	0	0	1150	0	0	2)	
	35	0	0	0	0	0	0	0	0	0	0	1065	0	0	2)	
	40	0	0	0	0	0	0	0	0	0	0	0	0	0	2)	
6,5	Static	0	0	0	0	0	0	0	0	0	0	1700	0	0	2)	25 X 6
	1	0	0	0	0	0	0	0	0	0	0	1700	0	0	2)	
	5	0	0	0	0	0	0	0	0	0	0	1700	0	0	2)	
	10	0	0	0	0	0	0	0	0	0	0	1700	0	0	2)	
	20	0	0	0	0	0	0	0	0	0	0	1700	0	0	2)	
	25	0	0	0	0	0	0	0	0	0	0	1700	0	0	2)	
	35	0	0	0	0	0	0	0	0	0	0	1575	0	0	2)	
	40	0	0	0	0	0	0	0	0	0	0	0	0	0	2)	
50	0	0	0	0	0	0	0	0	0	0	0	0	0	2)		

Technical Data Industrial Crossply Tires

Size range, specifications and tire load capacities

Tire									Tire dimensions [mm]					Min. Dual Spacing
Size	Pattern	Tire Type	LI	SSY	PR	Rim	Tube	Flap	Article approximate data					
									Tread depth	Width	Outer dia.	Static ¹⁾ rad.	Rolling ¹⁾ circ.	
25 X 6	IC40	TT	126	A5	8	3.75 P-13	S 25x6 F	B 100 - 13	22.5	171	675	312	2087	204
7.00 - 15	IC10	TT	138	A5	12	5.5 - 15	S 7.00 - 15 F	B 170 - 15 reinforce	12.3	195	736	336	2212	236
7.50 - 15	IC10	TT	146	A5	16	6.0 - 15	7.50 - 15 F	B 170 - 15 reinforce	13.2	208	760	349	2284	254 / (260)
7.50 - 15	IC40	TT	144	A5	14	6.0 - 15	S 7.50 - 15 F	B 170 - 15	23.5	210	774	363	2391	254 / (260)
8.25 - 15	IC10	TT	153	A5	18	6.5 - 15	S 8.25 - 15 F	B 170 - 15 reinforce	14.5	228	814	374	2516	281
8.25 - 15	IC40	TT	153	A5	18	6.5 - 15	S 8.25 - 15 F	B 170 - 15 reinforce	28.0	238	836	390	2575	281

1) At reference load.

2) Other vehicles: platform trucks, trailers, tractive units, straddle carriers, fork lifts without counterweight, terminal tractors etc.

3) For tire used with straddle carriers and straddle fork lifts with max. speed 25 km/h and 35 km/h the load capacities of steered wheels on fork lifts have to be used.

Inflation Pressure [bar]	Application	Reach Stackers, Counterbalanced Lift Trucks, Loaded Container Handlers, Empty Container Handlers		Rubber Tire Gantry Crane	Straddle/Shuttle Carriers	Ro-Ro Terminal Tractors	Terminal Tractors and Trailers	Automated Guided Vehicles (AGVs)	Sider Loader (Fork lift/Reach stacker)	Towbar Airport Tractor	Towbarless airport tractor	Small Ground Support Airport Tractor	Hot slag transporter	Heavy lift transport	Other vehicles	Please consult Continental	Size											
		Load Wheel	Steer Wheel																									
		Cycle Length (one way) km	1,6															0,6	2,5	2,5	2,5	1,6	1,6	7,0	7,0	2,0	3,0	10,0
		Max. laden speed (km/h)	25															8	35	20	40	25	30	32	32	30	15	3
Cyclic Load	Yes	Yes	Yes	Yes	Yes	Yes	Yes	Yes	No	Yes	No	Yes	No															
Speed	Load[kg]															Size												
6,5	Static	0	0	0	0	0	0	0	0	0	0	0	1700	0	0	2)	25 X 6											
	1	0	0	0	0	0	0	0	0	0	0	0	1700	0	0	2)												
	5	0	0	0	0	0	0	0	0	0	0	0	1700	0	0	2)												
	10	0	0	0	0	0	0	0	0	0	0	0	1700	0	0	2)												
	20	0	0	0	0	0	0	0	0	0	0	0	1700	0	0	2)												
	25	0	0	0	0	0	0	0	0	0	0	0	1700	0	0	2)												
	35	0	0	0	0	0	0	0	0	0	0	0	1575	0	0	2)												
	40	0	0	0	0	0	0	0	0	0	0	0	0	0	0	2)												
8,25	Static	3540	2835	0	0	0	0	0	3540	0	2)	2360	0	0	2)	7.00 - 15												
	1	3070	2480	0	0	0	0	0	2715	0	2)	2360	0	0	2)													
	5	3070	2480	0	0	0	0	0	2715	0	2)	2360	0	0	2)													
	10	3070	2480	0	0	0	0	0	2715	0	2)	2360	0	0	2)													
	20	3070	2360	0	0	0	0	0	2600	0	2)	2360	0	0	2)													
	25	3070	2360	0	0	0	0	0	2360	0	2)	2360	0	0	2)													
	35	2950	2185	0	0	0	0	0	2185	0	2)	2185	0	0	2)													
	40	0	0	0	0	0	0	0	0	0	2)	0	0	0	2)													
10	Static	4500	3600	0	0	0	0	0	4500	3000	4500	3000	0	0	2)	7.50 - 15												
	1	3900	3150	0	0	0	0	0	3450	3000	3900	3000	0	0	2)													
	5	3900	3150	0	0	0	0	0	3450	3000	3900	3000	0	0	2)													
	10	3900	3150	0	0	0	0	0	3450	3000	3900	3000	0	0	2)													
	20	3900	3000	0	0	0	0	0	3300	3000	3000	3000	0	0	2)													
	25	3900	3000	0	0	0	0	0	3000	3000	3000	3000	0	0	2)													
	35	3750	2775	0	0	0	0	0	2775	2775	2775	2775	0	0	2)													
	40	0	0	0	0	0	0	0	0	0	0	0	0	0	2)													
9,25	Static	4200	3360	0	0	0	0	0	4200	2800	4200	2800	0	0	2)	7.50 - 15												
	1	3640	2940	0	0	0	0	0	3220	2800	3640	2800	0	0	2)													
	5	3640	2940	0	0	0	0	0	3220	2800	3640	2800	0	0	2)													
	10	3640	2940	0	0	0	0	0	3220	2800	3640	2800	0	0	2)													
	20	3640	2800	0	0	0	0	0	3080	2800	2800	2800	0	0	2)													
	25	3640	2800	0	0	0	0	0	2800	2800	2800	2800	0	0	2)													
	35	3500	2590	0	0	0	0	0	2590	2590	2590	2590	0	0	2)													
	40	0	0	0	0	0	0	0	0	0	0	0	0	0	2)													
10	Static	5475	4380	0	0	0	4745	0	5475	3650	5475	3650	2)	5475	2)	8.25 - 15												
	1	4745	3835	0	0	0	4745	0	4200	3650	4745	3650	2)	4745	2)													
	5	4745	3835	0	0	0	4745	0	4200	3650	4745	3650	2)	4745	2)													
	10	4745	3835	0	0	0	4745	0	4200	3650	4745	3650	2)	3835	2)													
	20	4745	3650	0	0	0	4110	0	4015	3650	3650	3650	2)	3650	2)													
	25	4745	3650	0	0	0	4110	0	3650	3650	3650	3650	2)	3650	2)													
	35	4565	3380	0	0	0	3650	0	3380	3380	3380	3380	2)	0	2)													
	40	0	0	0	0	0	3650	0	0	0	0	0	2)	0	2)													
10	Static	5475	4380	0	0	0	4745	0	5475	3650	5475	3650	2)	5475	2)	8.25 - 15												
	1	4745	3835	0	0	0	4745	0	4200	3650	4745	3650	2)	4745	2)													
	5	4745	3835	0	0	0	4745	0	4200	3650	4745	3650	2)	4745	2)													
	10	4745	3835	0	0	0	4745	0	4200	3650	4745	3650	2)	3835	2)													
	20	4745	3650	0	0	0	4110	0	4015	3650	3650	3650	2)	3650	2)													
	25	4745	3650	0	0	0	4110	0	3650	3650	3650	3650	2)	3650	2)													
	35	4565	3380	0	0	0	3650	0	3380	3380	3380	3380	2)	0	2)													
	40	0	0	0	0	0	3650	0	0	0	0	0	2)	0	2)													

Technical Data Industrial Crossply Tires

Size range, specifications and tire load capacities

Tire									Tire dimensions [mm]					
Size	Pattern	Tire Type	LI	SSY	PR	Rim	Tube	Flap	Article approximate data					Min. Dual Spacing
									Tread depth	Width	Outer dia.	Static ¹⁾ rad.	Rolling ¹⁾ circ.	
28 X 9 - 15	IC12	TT	146	A5	14	7.5 - 15	S 28x9 - 15 F	B 190 - 15 reinforc	10.7	211	701	319	2144	248
28 X 9 - 15	IC40	TT	146	A5	14	7.0 - 15	S 28x-15 F	B 190-15 reinforced	18.5	226	720	333	2196	248
28 X 9 - 15	IC40	TT	146	A5	14	7.0 - 15	S 28x9-15 F	B 190-15 reinforced	18.5	223	720	334	2196	248
250 - 15	IC12	TT	153	A5	18	7.0 - 15	S 250 - 15 F	B 190 - 15 reinforc	14.0	225	728	336	2224	282 / (288)
250 - 15	IC40	TT	153	A5	18	7.0 - 15	S 250 - 15 F	B 190 - 15	21.5	230	737	347	2248	282 / (288)
300 - 15	IC40	TT	165	A5	22	8.0 - 15	S 300 - 15 F	B 190 - 15	26.5	297	819	375	2477	345

1) At reference load.

2) Other vehicles: platform trucks, trailers, tractive units, straddle carriers, fork lifts without counterweight, terminal tractors etc.

3) For tire used with straddle carriers and straddle fork lifts with max. speed 25 km/h and 35 km/h the load capacities of steered wheels on fork lifts have to be used.

Inflation Pressure [bar]	Application	Reach Stackers, Counterbalanced Lift Trucks, Loaded Container Handlers, Empty Container Handlers		Rubber Tire Gantry Crane	Straddle/Shuttle Carriers	Ro-Ro Terminal Tractors	Terminal Tractors and Trailers	Automated Guided Vehicles (AGVs)	Sider Loader (Fork lift/Reach stacker)	Towbar Airport Tractor	Towbarless airport tractor	Small Ground Support Airport Tractor	Hot slag transporter	Heavy lift transport	Other vehicles	Size
		Load Wheel	Steer Wheel													
	Cycle Length (one way) km	1,6		0,6	2,5	2,5	2,5	1,6	1,6	7,0	7,0	2,0	3,0	10,0	Please consult Continental	
	Max. laden speed (km/h)	25		8	35	20	40	25	30	32	32	30	15	3		
Cyclic Load	Yes		Yes	Yes	Yes	Yes	Yes	Yes	No	Yes	No	Yes	No			
Speed		Load[kg]													Size	
10	Static	4500	3600	0	0	0	3900	0	4500	3000	4500	3000	0	0		2)
	1	3900	3150	0	0	0	3900	0	3450	3000	3900	3000	0	0	2)	
	5	3900	3150	0	0	0	3900	0	3450	3000	3900	3000	0	0	2)	
	10	3900	3150	0	0	0	3900	0	3450	3000	3900	3000	0	0	2)	
	20	3900	3000	0	0	0	3375	0	3300	3000	3000	3000	0	0	2)	
	25	3900	3000	0	0	0	3375	0	3000	3000	3000	3000	0	0	2)	
	35	3750	2775	0	0	0	3000	0	2775	2775	2775	2775	0	0	2)	
	40	0	0	0	0	0	3000	0	0	0	0	0	0	0	2)	
10	Static	4500	3600	0	0	0	3900	0	4500	3000	4500	3000	0	0	2)	28 X 9 - 15
	1	3900	3150	0	0	0	3900	0	3450	3000	3900	3000	0	0	2)	
	5	3900	3150	0	0	0	3900	0	3450	3000	3900	3000	0	0	2)	
	10	3900	3150	0	0	0	3900	0	3450	3000	3900	3000	0	0	2)	
	20	3900	3000	0	0	0	3375	0	3300	3000	3000	3000	0	0	2)	
	25	3900	3000	0	0	0	3375	0	3000	3000	3000	3000	0	0	2)	
	35	3750	2775	0	0	0	3000	0	2775	2775	2775	2775	0	0	2)	
	40	0	0	0	0	0	3000	0	0	0	0	0	0	0	2)	
10	Static	4500	3600	0	0	0	3900	0	4500	3000	4500	3000	0	0	2)	28 X 9 - 15
	1	3900	3150	0	0	0	3900	0	3450	3000	3900	3000	0	0	2)	
	5	3900	3150	0	0	0	3900	0	3450	3000	3900	3000	0	0	2)	
	10	3900	3150	0	0	0	3900	0	3450	3000	3900	3000	0	0	2)	
	20	3900	3000	0	0	0	3375	0	3300	3000	3000	3000	0	0	2)	
	25	3900	3000	0	0	0	3375	0	3000	3000	3000	3000	0	0	2)	
	35	3750	2775	0	0	0	3000	0	2775	2775	2775	2775	0	0	2)	
	40	0	0	0	0	0	3000	0	0	0	0	0	0	0	2)	
9,5	Static	5475	4380	0	0	0	4745	0	5475	3650	5475	3650	0	0	2)	250 - 15
	1	4745	3835	0	0	0	4745	0	4200	3650	4745	3650	0	0	2)	
	5	4745	3835	0	0	0	4745	0	4200	3650	4745	3650	0	0	2)	
	10	4745	3835	0	0	0	4745	0	4200	3650	4745	3650	0	0	2)	
	20	4745	3650	0	0	0	4110	0	4015	3650	3650	3650	0	0	2)	
	25	4745	3650	0	0	0	4110	0	3650	3650	3650	3650	0	0	2)	
	35	4565	3380	0	0	0	3650	0	3380	3380	3380	3380	0	0	2)	
	40	0	0	0	0	0	3650	0	0	0	0	0	0	0	2)	
9,5	Static	5475	4380	0	0	0	4745	0	5475	3650	5475	3650	0	0	2)	250 - 15
	1	4745	3835	0	0	0	4745	0	4200	3650	4745	3650	0	0	2)	
	5	4745	3835	0	0	0	4745	0	4200	3650	4745	3650	0	0	2)	
	10	4745	3835	0	0	0	4745	0	4200	3650	4745	3650	0	0	2)	
	20	4745	3650	0	0	0	4110	0	4015	3650	3650	3650	0	0	2)	
	25	4745	3650	0	0	0	4110	0	3650	3650	3650	3650	0	0	2)	
	35	4565	3380	0	0	0	3650	0	3380	3380	3380	3380	0	0	2)	
	40	0	0	0	0	0	3650	0	0	0	0	0	0	0	2)	
10	Static	7725	6180	0	0	0	6695	0	7725	5150	7725	2)	2)	7725	2)	300 - 15
	1	6695	5410	0	0	0	6695	0	5925	5150	6695	2)	2)	6695	2)	
	5	6695	5410	0	0	0	6695	0	5925	5150	6695	2)	2)	6695	2)	
	10	6695	5410	0	0	0	6695	0	5925	5150	6695	2)	2)	5410	2)	
	20	6695	5150	0	0	0	5795	0	5665	5150	5150	2)	2)	5150	2)	
	25	6695	5150	0	0	0	5795	0	5150	5150	5150	2)	2)	5150	2)	
	35	6440	4765	0	0	0	5150	0	4765	4765	4765	2)	2)	0	2)	
	40	0	0	0	0	0	5150	0	0	0	0	2)	2)	0	2)	
50	0	0	0	0	0	0	0	0	0	0	2)	2)	0	2)		

Technical Data Industrial Crossply Tires

Size range, specifications and tire load capacities

Tire									Tire dimensions [mm]					
Size	Pattern	Tire Type	LI	SSY	PR	Rim	Tube	Flap	Article approximate data					Min. Dual Spacing
									Tread depth	Width	Outer dia.	Static ¹⁾ rad.	Rolling ¹⁾ circ.	
355/65 - 15	IC40	TL	170	A5	24	9.75 - 15	S 355 / 65 - 15 F	B 240 - 15	28.2	334	840	388	2564	407
10.00 - 20	IC40	TL	166	A5	18	7.5-20	S 10.00-20 F	B 190-20	30.0	288	1077	503	3311	337
12.00 - 20	IC40	TL	176	A5	20	8.5 - 20	12.00-20 F	B230-20 reinforced	34.0	315	1157	534	-	376

1) At reference load.

2) Other vehicles: platform trucks, trailers, tractive units, straddle carriers, fork lifts without counterweight, terminal tractors etc.

3) For tire used with straddle carriers and straddle fork lifts with max. speed 25 km/h and 35 km/h the load capacities of steered wheels on fork lifts have to be used.

Inflation Pressure [bar]	Application	Reach Stackers, Counterbalanced Lift Trucks, Loaded Container Handlers, Empty Container Handlers		Rubber Tire Gantry Crane	Straddle/Shuttle Carriers	Ro-Ro Terminal Tractors	Terminal Tractors and Trailers	Automated Guided Vehicles (AGVs)	Sider Loader (Fork lift/Reach stacker)	Towbar Airport Tractor	Towbarless airport tractor	Small Ground Support Airport Tractor	Hot slag transporter	Heavy lift transport	Other vehicles	Please consult Continental	Size										
		Load Wheel	Steer Wheel																								
		Cycle Length (one way) km	1,6															0,6	2,5	2,5	1,6	1,6	7,0	7,0	2,0	3,0	10,0
		Max. laden speed (km/h)	25															8	35	20	40	25	30	32	32	30	15
Cyclic Load	Yes	Yes	Yes	Yes	Yes	Yes	Yes	Yes	No	Yes	No	Yes	No														
Speed	Load[kg]														Size												
10	Static	9000	7200	0	0	0	7800	0	9000	6000	9000	2)	2)	9000	2)	355/65 - 15											
	1	7800	6300	0	0	0	7800	0	6900	6000	7800	2)	2)	7800	2)												
	5	7800	6300	0	0	0	7800	0	6900	6000	7800	2)	2)	7800	2)												
	10	7800	6300	0	0	0	7800	0	6900	6000	7800	2)	2)	6300	2)												
	20	7800	6000	0	0	0	6750	0	6600	6000	6000	2)	2)	6000	2)												
	25	7800	6000	0	0	0	6750	0	6000	6000	6000	2)	2)	6000	2)												
	35	7500	5550	0	0	0	6000	0	5550	5550	5550	2)	2)	0	2)												
	40	0	0	0	0	0	6000	0	0	0	0	2)	2)	0	2)												
10	Static	7950	6360	0	0	6890	6890	2)	7950	5300	7950	0	2)	7950	2)	10.00 - 20											
	1	6890	5565	0	0	6890	6890	2)	6095	5300	6890	0	2)	6890	2)												
	5	6890	5565	0	0	6890	6890	2)	6095	5300	6890	0	2)	6890	2)												
	10	6890	5565	0	0	6890	6890	2)	6095	5300	6890	0	2)	5565	2)												
	20	6890	5300	0	0	5965	5965	2)	5830	5300	5300	0	2)	5300	2)												
	25	6890	5300	0	0	5965	5965	2)	5300	5300	5300	0	2)	5300	2)												
	35	6625	4905	0	0	5300	5300	2)	4905	4905	4905	0	2)	0	2)												
	40	0	0	0	0	5300	5300	2)	0	0	0	0	2)	0	2)												
10	Static	10650	8520	0	0	9230	9230	2)	10650	7100	10650	0	2)	10650	2)	12.00 - 20											
	1	9230	7455	0	0	9230	9230	2)	8165	7100	9230	0	2)	9230	2)												
	5	9230	7455	0	0	9230	9230	2)	8165	7100	9230	0	2)	9230	2)												
	10	9230	7455	0	0	9230	9230	2)	8165	7100	9230	0	2)	7455	2)												
	20	9230	7100	0	0	7990	7990	2)	7810	7100	7100	0	2)	7100	2)												
	25	9230	7100	0	0	7990	7990	2)	7100	7100	7100	0	2)	7100	2)												
	35	8875	6570	0	0	7100	7100	2)	6570	6570	6570	0	2)	0	2)												
	40	0	0	0	0	7100	7100	2)	0	0	0	0	2)	0	2)												
50	0	0	0	0	0	0	2)	0	0	0	0	2)	0	2)													

Port Operations Tires - V.ply



DockMaster+

- › Increased lifetime
- › Reduced oscillation
- › Increased abrasion resistance

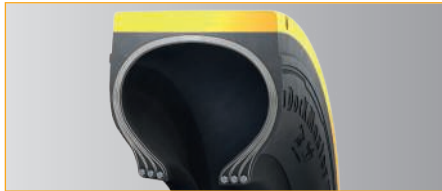

Maximum tread volume for a slick tire

Increased lifetime



Wide and flat tread area

Higher stacking efficiency (minimizes time required to align container during stacking)

Stable load platform reduces oscillation of container mast



Increased abrasion resistance in demanding applications (turning on the spot) due to increased tensile strength

High mileage in pick and stack applications

Reduced risk of tread cracks



CraneMaster

- › Outstanding maneuverability
- › Reduced risk of tread cracks during stationary turns
- › Stability at slow speeds and with stationary high loads

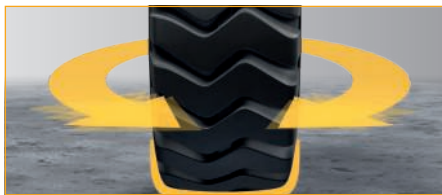

Tread blocks with rounded tread contour and narrow tread blocks

Outstanding maneuverability

Reduced tread stress and cracks during turning on the spot



Stability in slow speed and stationary high load situations

Reduced risk of groove cracks and heat build-up

Stable load platform

Port Operations Tires - V.ply



TerminalMaster V.ply

- › High stability on hard, smooth and flat surfaces
- › Perfect traction
- › High levels of traction and steering response due to special compound and tread design



Precise track holding

Closed shoulder tread design ensures stability on straight lines and corners



Reduced tread vibration**

Three-ribbed tread design for low tread movement

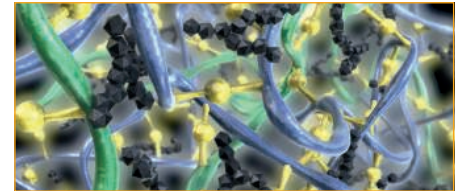

Increased lifetime

Resistance to abrasion due to Plus Compound



ContainerMaster+

- › Excellent resistance to wear, even on highly abrasive ground surfaces
- › Maximum resistance to tread cracks, even while steering in stationary positions



Solid tread blocks

The solid tread blocks provide maximum stability, even under extreme conditions

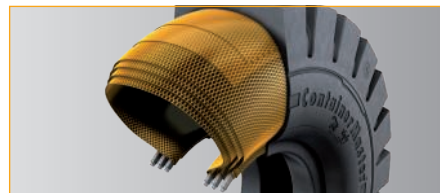

V.ply for maximum stability

Multiple V.ply layers provide additional rigidity to the tread area and allow for ultra-strong sidewalls

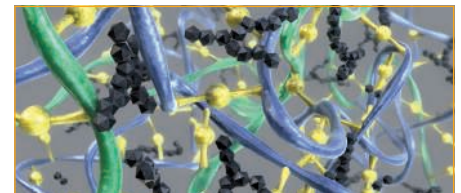

Continental Port Plus Compound for maximum robustness

The Continental Port Plus Compound ensures excellent resistance to wear, especially on highly abrasive ground surfaces and when steering in stationary positions

Technical Data Material Handling - OTR V.Ply

Size range, specifications and tire load capacities

Size	Pattern	Tire									Tire dimensions [mm]						
		Tread Code	Tire Type	Code			Recom. rim	Tube	Flap	O-Ring	Article approximate data						
				LI	SSY	PR					Tread depth	Width	Outer dia.	Static rad. ¹⁾	Rolling rad. ¹⁾	Min. Dual Spacing	Infl. Press. [bar]
12.00 - 24	ContainerMaster	E-4	TT	178	A5	20	8.5 / 1.7 (drop center)	S 12.00-24 F	B 220-24 REINF. AIRF	-	35.5	332	1289	599	-	-	10
12.00 - 24	ContainerMaster+	IND-4	TT	178	A5	20	8.50 / 1.7	S 12.00-24 F	B 220-24 REINF. AIRF	-	35.5	332	1289	599	-	-	10
12.00 - 24	ContainerMaster+	IND-4	TL	178	A5	20	8.50 / 1.7	-	-	OR 325T	35.5	332	1289	599	-	-	10
14.00 - 24	ContainerMaster+	IND-4	TT	188	A5	28	10.00-24 WA	S 14.00-24 F	B 220-24 REINF. AIRF	-	47.0	395	1405	635	4089	450	10
14.00 - 24	ContainerMaster+	IND-4	TL	188	A5	28	10.00-24 WA	-	-	OR 325 T / OR 324 T	47.0	395	1405	635	4089	450	10

1) At reference load

2) Please contact Continental Technical Customer Service or Sales representative for clarification

Application	Reach Stackers, Counterbalanced Lift Trucks, Loaded Container Handlers, Empty Container Handlers		Rubber Tire Gantry Crane	Straddle/Shuttle Carriers	Ro-Ro Terminal Tractors	Terminal Tractors and Trailers	Automated Guided Vehicles (AGVs)	Sider Loader (Fork lift/Reach stacker)	Towbar Airport Tractor	Towbarless airport tractor	Small Ground Support Airport Tractor	Hot slag transporter	Heavy lift transport	Other vehicles	
	Load Wheel	Steer Wheel													
Cycle Length (one way) km	1,6		0,6	2,5	2,5	2,5	1,6	1,6	7,0	7,0	2,0	3,0	10,0	Please consult Continental	
Max. laden speed (km/h)	25		8	35	20	40	25	30	32	32	30	15	3		
Cyclic Load	Yes		Yes	Yes	Yes	Yes	Yes	Yes	No	Yes	No	Yes	No		
Speed	Load(kgJ)														Size
Static	11250	9000	2)	0	9750	2)	2)	11250	7500	11250	7500	11250	11250	11250	12.00 - 24
1	9750	7875	2)	0	9750	2)	2)	8625	7500	9750	7500	9750	9750	9750	
5	9750	7875	2)	0	9750	2)	2)	8625	7500	9750	7500	9750	9750	9750	
10	9750	7875	2)	0	9750	2)	2)	8625	7500	9750	7500	9750	7875	9750	
20	9750	7500	2)	0	8440	2)	2)	8250	7500	7500	7500	7500	7500	7500	
25	9750	7500	2)	0	8440	2)	2)	7500	7500	7500	7500	7500	7500	7500	
35	9375	6940	2)	0	7500	2)	2)	6940	6940	6940	6940	6940	0	6940	
40	0	0	2)	0	7500	2)	2)	0	0	0	0	0	0	6675	
50	0	0	2)	0	0	2)	2)	0	0	0	0	0	0	6300	
Static	11250	9000	2)	0	9750	2)	2)	11250	7500	11250	7500	11250	11250	11250	12.00 - 24
1	9750	7875	2)	0	9750	2)	2)	8625	7500	9750	7500	9750	9750	9750	
5	9750	7875	2)	0	9750	2)	2)	8625	7500	9750	7500	9750	9750	9750	
10	9750	7875	2)	0	9750	2)	2)	8625	7500	9750	7500	9750	7875	9750	
20	9750	7500	2)	0	8440	2)	2)	8250	7500	7500	7500	7500	7500	7500	
25	9750	7500	2)	0	8440	2)	2)	7500	7500	7500	7500	7500	7500	7500	
35	9375	6940	2)	0	7500	2)	2)	6940	6940	6940	6940	6940	0	6940	
40	0	0	2)	0	7500	2)	2)	0	0	0	0	0	0	6675	
50	0	0	2)	0	0	2)	2)	0	0	0	0	0	0	6300	
Static	11250	9000	2)	0	9750	2)	2)	11250	7500	11250	7500	11250	11250	11250	12.00 - 24
1	9750	7875	2)	0	9750	2)	2)	8625	7500	9750	7500	9750	9750	9750	
5	9750	7875	2)	0	9750	2)	2)	8625	7500	9750	7500	9750	9750	9750	
10	9750	7875	2)	0	9750	2)	2)	8625	7500	9750	7500	9750	7875	9750	
20	9750	7500	2)	0	8440	2)	2)	8250	7500	7500	7500	7500	7500	7500	
25	9750	7500	2)	0	8440	2)	2)	7500	7500	7500	7500	7500	7500	7500	
35	9375	6940	2)	0	7500	2)	2)	6940	6940	6940	6940	6940	0	6940	
40	0	0	2)	0	7500	2)	2)	0	0	0	0	0	0	6675	
50	0	0	2)	0	0	2)	2)	0	0	0	0	0	0	6300	
Static	15000	12000	2)	0	13000	2)	2)	15000	10000	15000	10000	15000	15000	15000	14.00 - 24
1	13000	10500	2)	0	13000	2)	2)	11500	10000	13000	10000	13000	13000	13000	
5	13000	10500	2)	0	13000	2)	2)	11500	10000	13000	10000	13000	13000	13000	
10	13000	10500	2)	0	13000	2)	2)	11500	10000	13000	10000	13000	10500	13000	
20	13000	10000	2)	0	11250	2)	2)	11000	10000	10000	10000	10000	10000	10000	
25	13000	10000	2)	0	11250	2)	2)	10000	10000	10000	10000	10000	10000	10000	
35	12500	9250	2)	0	10000	2)	2)	9250	9250	9250	9250	9250	0	9250	
40	0	0	2)	0	10000	2)	2)	0	0	0	0	0	0	8900	
50	0	0	2)	0	0	2)	2)	0	0	0	0	0	0	8400	
Static	15000	12000	2)	0	13000	2)	2)	15000	10000	15000	10000	15000	15000	15000	14.00 - 24
1	13000	10500	2)	0	13000	2)	2)	11500	10000	13000	10000	13000	13000	13000	
5	13000	10500	2)	0	13000	2)	2)	11500	10000	13000	10000	13000	13000	13000	
10	13000	10500	2)	0	13000	2)	2)	11500	10000	13000	10000	13000	10500	13000	
20	13000	10000	2)	0	11250	2)	2)	11000	10000	10000	10000	10000	10000	10000	
25	13000	10000	2)	0	11250	2)	2)	10000	10000	10000	10000	10000	10000	10000	
35	12500	9250	2)	0	10000	2)	2)	9250	9250	9250	9250	9250	0	9250	
40	0	0	2)	0	10000	2)	2)	0	0	0	0	0	0	8900	
50	0	0	2)	0	0	2)	2)	0	0	0	0	0	0	8400	

Technical Data Material Handling - OTR V.Ply

Size range, specifications and tire load capacities

Size	Pattern	Tire									Tire dimensions [mm]						
		Code		LI	SSY	PR	Recom. rim	Tube	Flap	O-Ring	Article approximate data						
		Tread Code	Tire Type								Tread depth	Width	Outer dia.	Static rad. ¹⁾	Rolling ¹⁾ circ.	Min. Dual Spacing	Infl. Press. [bar]
14.00 - 24	CraneMaster	IND-3	TL	188	A5	28	10.00-24 WA	-	-	OR 325 T / OR 324 T	29.0	381	1356	659	4141	450	10
14.00 - 24	CraneMaster	IND-3	TT	188	A5	28	10.00-24 WA	S 14.00-24 F	B 220-24 REINF. AIRF	-	29.0	381	1356	659	4141	450	10
14.00 - 24	DockMaster+	IND-3S	TT	188	A5	28	10.00-24 WA	S 14.00-24 F	B 220-24 REINF. AIRF	-	27.5	383	1370	-	-	450	10
14.00 - 24	DockMaster+	IND-3S	TL	188	A5	28	10.00-24 WA	-	-	OR 325 T / OR 324 T	27.5	383	1370	-	-	450	10
16.00 - 25	ContainerMaster	E-4	TL	196	A5	32	11.25 / 2.0	-	-	OR 325T	55.5	456	1548	693	-	518	10

1) At reference load

2) Please contact Continental Technical Customer Service or Sales representative for clarification

Application	Reach Stackers, Counterbalanced Lift Trucks, Loaded Container Handlers, Empty Container Handlers		Rubber Tire Gantry Crane	Saddle/Shuttle Carriers	Ro-Ro Terminal Tractors	Terminal Tractors and Trailers	Automated Guided Vehicles (AGVs)	Sider Loader (Fork lift/Reach stacker)	Towbar Airport Tractor	Towbarless airport tractor	Small Ground Support Airport Tractor	Hot slag transporter	Heavy lift transport	Other vehicles
	Load Wheel	Steer Wheel												
Cycle Length (one way) km	1,6		0,6	2,5	2,5	2,5	1,6	1,6	7,0	7,0	2,0	3,0	10,0	Please consult Continental
Max. laden speed (km/h)	25		8	35	20	40	25	30	32	32	30	15	3	
Cyclic Load	Yes		Yes	Yes	Yes	Yes	Yes	Yes	No	Yes	No	Yes	No	
Speed	Load(kgJ)													Size
Static	2)	2)	15000	0	2)	2)	2)	2)	2)	2)	2)	2)	2)	2)
1	2)	2)	13000	0	2)	2)	2)	2)	2)	2)	2)	2)	2)	2)
5	2)	2)	13000	0	2)	2)	2)	2)	2)	2)	2)	2)	2)	2)
10	2)	2)	13000	0	2)	2)	2)	2)	2)	2)	2)	2)	2)	2)
20	2)	2)	13000	0	2)	2)	2)	2)	2)	2)	2)	2)	2)	2)
25	2)	2)	13000	0	2)	2)	2)	2)	2)	2)	2)	2)	2)	2)
35	2)	2)	12500	0	2)	2)	2)	2)	2)	2)	2)	2)	2)	2)
40	2)	2)	0	0	2)	2)	2)	2)	2)	2)	2)	2)	2)	2)
50	2)	2)	0	0	2)	2)	2)	2)	2)	2)	2)	2)	2)	2)
Static	2)	2)	15000	0	2)	2)	2)	2)	2)	2)	2)	2)	2)	2)
1	2)	2)	13000	0	2)	2)	2)	2)	2)	2)	2)	2)	2)	2)
5	2)	2)	13000	0	2)	2)	2)	2)	2)	2)	2)	2)	2)	2)
10	2)	2)	13000	0	2)	2)	2)	2)	2)	2)	2)	2)	2)	2)
20	2)	2)	13000	0	2)	2)	2)	2)	2)	2)	2)	2)	2)	2)
25	2)	2)	13000	0	2)	2)	2)	2)	2)	2)	2)	2)	2)	2)
35	2)	2)	12500	0	2)	2)	2)	2)	2)	2)	2)	2)	2)	2)
40	2)	2)	0	0	2)	2)	2)	2)	2)	2)	2)	2)	2)	2)
50	2)	2)	0	0	2)	2)	2)	2)	2)	2)	2)	2)	2)	2)
Static	15000	12000	0	0	13000	2)	2)	15000	10000	15000	10000	15000	15000	15000
1	13000	10500	0	0	13000	2)	2)	11500	10000	13000	10000	13000	13000	13000
5	13000	10500	0	0	13000	2)	2)	11500	10000	13000	10000	13000	13000	13000
10	13000	10500	0	0	13000	2)	2)	11500	10000	13000	10000	13000	10500	13000
20	13000	10000	0	0	11250	2)	2)	11000	10000	10000	10000	10000	10000	10000
25	13000	10000	0	0	11250	2)	2)	10000	10000	10000	10000	10000	10000	10000
35	12500	9250	0	0	10000	2)	2)	9250	9250	9250	9250	9250	0	9250
40	0	0	0	0	10000	2)	2)	0	0	0	0	0	0	8900
50	0	0	0	0	0	2)	2)	0	0	0	0	0	0	8400
Static	15000	12000	0	0	13000	2)	2)	15000	10000	15000	10000	15000	15000	15000
1	13000	10500	0	0	13000	2)	2)	11500	10000	13000	10000	13000	13000	13000
5	13000	10500	0	0	13000	2)	2)	11500	10000	13000	10000	13000	13000	13000
10	13000	10500	0	0	13000	2)	2)	11500	10000	13000	10000	13000	10500	13000
20	13000	10000	0	0	11250	2)	2)	11000	10000	10000	10000	10000	10000	10000
25	13000	10000	0	0	11250	2)	2)	10000	10000	10000	10000	10000	10000	10000
35	12500	9250	0	0	10000	2)	2)	9250	9250	9250	9250	9250	0	9250
40	0	0	0	0	10000	2)	2)	0	0	0	0	0	0	8900
50	0	0	0	0	0	2)	2)	0	0	0	0	0	0	8400
Static	18750	15000	2)	0	16250	2)	2)	18750	12500	18750	12500	18750	18750	18750
1	16250	13125	2)	0	16250	2)	2)	14375	12500	16250	12500	16250	16250	16250
5	16250	13125	2)	0	16250	2)	2)	14375	12500	16250	12500	16250	16250	16250
10	16250	13125	2)	0	16250	2)	2)	14375	12500	16250	12500	16250	13125	16250
20	16250	12500	2)	0	14065	2)	2)	13750	12500	12500	12500	12500	12500	12500
25	16250	12500	2)	0	14065	2)	2)	12500	12500	12500	12500	12500	12500	12500
35	15625	11565	2)	0	12500	2)	2)	11565	11565	11565	11565	11565	0	11565
40	0	0	2)	0	12500	2)	2)	0	0	0	0	0	0	11125
50	0	0	2)	0	0	2)	2)	0	0	0	0	0	0	10500

Technical Data Material Handling - OTR V.Ply

Size range, specifications and tire load capacities

Size	Pattern	Tire									Tire dimensions [mm]						
		Tread Code	Tire Type	Code			Recom. rim	Tube	Flap	O-Ring	Article approximate data						
				LI	SSY	PR					Tread depth	Width	Outer dia.	Static ¹⁾ rad.	Rolling ¹⁾ circ.	Min. Dual Spacing	Infl. Press. [bar]
16.00 - 25	ContainerMaster+	E-4	TL	196	A5	32	11.25 / 2.0	-	-	OR 325T	55.5	456	1548	693	-	518	10
16.00 - 25	CraneMaster	E-3	TL	196	A5	32	11.25 / 2.0	-	-	OR 325T	35.5	445	1465	669	4418	518	10
16.00 - 25	StraddleMaster +	E-4	TL	196	A5	32	11.25 / 2.0	-	-	OR 325T	54.0	461	1529	699	-	-	10
16.00 - 25	TerminalMaster V.ply	IND-4	TL	196	A5	32	11.25 / 2.0	-	-	OR 325T	54.0	461	1529	699	-	-	10
18.00 - 25	ContainerMaster+	E-4	TL	207	A5	40	13.00 / 2.5	-	-	OR 325T	64.5	516	1673	761	5046	598	10

1) At reference load

2) Please contact Continental Technical Customer Service or Sales representative for clarification

Application	Reach Stackers, Counterbalanced Lift Trucks, Loaded Container Handlers, Empty Container Handlers		Rubber Tire Gantry Crane	Straddle/Shuttle Carriers	Ro-Ro Terminal Tractors	Terminal Tractors and Trailers	Automated Guided Vehicles (AGVs)	Sider Loader (Fork lift/Reach stacker)	Towbar Airport Tractor	Towbarless airport tractor	Small Ground Support Airport Tractor	Hot slag transporter	Heavy lift transport	Other vehicles	
	Load Wheel	Steer Wheel													
Cycle Length (one way) km	1,6		0,6	2,5	2,5	2,5	1,6	1,6	7,0	7,0	2,0	3,0	10,0	Please consult Continental	
Max. laden speed (km/h)	25		8	35	20	40	25	30	32	32	30	15	3		
Cyclic Load	Yes		Yes	Yes	Yes	Yes	Yes	Yes	No	Yes	No	Yes	No		
Speed	Load(kgJ)														Size
Static	18750	15000	2)	0	16250	2)	2)	18750	12500	18750	12500	18750	18750	18750	16.00 - 25
1	16250	13125	2)	0	16250	2)	2)	14375	12500	16250	12500	16250	16250	16250	
5	16250	13125	2)	0	16250	2)	2)	14375	12500	16250	12500	16250	16250	16250	
10	16250	13125	2)	0	16250	2)	2)	14375	12500	16250	12500	16250	13125	16250	
20	16250	12500	2)	0	14065	2)	2)	13750	12500	12500	12500	12500	12500	12500	
25	16250	12500	2)	0	14065	2)	2)	12500	12500	12500	12500	12500	12500	12500	
35	15625	11565	2)	0	12500	2)	2)	11565	11565	11565	11565	11565	0	11565	
40	0	0	2)	0	12500	2)	2)	0	0	0	0	0	0	11125	
50	0	0	2)	0	0	2)	2)	0	0	0	0	0	0	10500	
Static	2)	2)	18750	0	2)	2)	2)	2)	2)	2)	2)	2)	2)	2)	16.00 - 25
1	2)	2)	16250	0	2)	2)	2)	2)	2)	2)	2)	2)	2)	2)	
5	2)	2)	16250	0	2)	2)	2)	2)	2)	2)	2)	2)	2)	2)	
10	2)	2)	16250	0	2)	2)	2)	2)	2)	2)	2)	2)	2)	2)	
20	2)	2)	16250	0	2)	2)	2)	2)	2)	2)	2)	2)	2)	2)	
25	2)	2)	16250	0	2)	2)	2)	2)	2)	2)	2)	2)	2)	2)	
35	2)	2)	15625	0	2)	2)	2)	2)	2)	2)	2)	2)	2)	2)	
40	2)	2)	0	0	2)	2)	2)	2)	2)	2)	2)	2)	2)	2)	
50	2)	2)	0	0	2)	2)	2)	2)	2)	2)	2)	2)	2)	2)	
Static	18750	15000	2)	0	16250	2)	18750	18750	12500	18750	12500	18750	18750	18750	16.00 - 25
1	16250	13125	2)	0	16250	2)	16250	14375	12500	16250	12500	16250	16250	16250	
5	16250	13125	2)	0	16250	2)	16250	14375	12500	16250	12500	16250	16250	16250	
10	16250	13125	2)	0	16250	2)	13125	14375	12500	16250	12500	16250	13125	16250	
20	16250	12500	2)	0	14065	2)	12500	13750	12500	12500	12500	12500	12500	12500	
25	16250	12500	2)	0	14065	2)	12500	12500	12500	12500	12500	12500	12500	12500	
35	15625	11565	2)	0	12500	2)	0	11565	11565	11565	11565	11565	0	11565	
40	0	0	2)	0	12500	2)	0	0	0	0	0	0	0	11125	
50	0	0	2)	0	0	2)	0	0	0	0	0	0	0	10500	
Static	18750	15000	2)	0	16250	2)	18750	18750	12500	18750	12500	18750	18750	18750	16.00 - 25
1	16250	13125	2)	0	16250	2)	16250	14375	12500	16250	12500	16250	16250	16250	
5	16250	13125	2)	0	16250	2)	16250	14375	12500	16250	12500	16250	16250	16250	
10	16250	13125	2)	0	16250	2)	16250	14375	12500	16250	12500	16250	13125	16250	
20	16250	12500	2)	0	14065	2)	16250	13750	12500	12500	12500	12500	12500	12500	
25	16250	12500	2)	0	14065	2)	16250	12500	12500	12500	12500	12500	12500	12500	
35	15625	11565	2)	0	12500	2)	0	11565	11565	11565	11565	11565	0	11565	
40	0	0	2)	0	12500	2)	0	0	0	0	0	0	0	11125	
50	0	0	2)	0	0	2)	0	0	0	0	0	0	0	10500	
Static	26250	21000	2)	0	22750	22750	26250	26250	17500	26250	17500	26250	26250	26250	18.00 - 25
1	22750	18375	2)	0	22750	22750	22750	20125	17500	22750	17500	22750	22750	22750	
5	22750	18375	2)	0	22750	22750	22750	20125	17500	22750	17500	22750	22750	22750	
10	22750	18375	2)	0	22750	22750	22750	20125	17500	22750	17500	22750	18375	22750	
20	22750	17500	2)	0	19690	19690	22750	19250	17500	17500	17500	17500	17500	17500	
25	22750	17500	2)	0	19690	19690	22750	17500	17500	17500	17500	17500	17500	17500	
35	21875	16190	2)	0	17500	17500	0	16190	16190	16190	16190	16190	0	16190	
40	0	0	2)	0	17500	17500	0	0	0	0	0	0	0	15575	
50	0	0	2)	0	0	0	0	0	0	0	0	0	0	14700	

Technical Data Material Handling - OTR V.Ply

Size range, specifications and tire load capacities

Size	Pattern	Tire									Tire dimensions [mm]						
		Tread Code	Tire Type	Code			Recom. rim	Tube	Flap	O-Ring	Article approximate data						
				LI	SSY	PR					Tread depth	Width	Outer dia.	Static rad. ¹⁾	Rolling ¹⁾ circ.	Min. Dual Spacing	Infl. Press. [bar]
18.00 - 25	ContainerMaster+ IND-3	IND-3	TL	207	A5	40	13.00 / 2.5	-	-	OR 325T	40.0	511	1622	740	4928	598	10
18.00 - 25	CraneMaster	E-3	TL	207	A5	40	13.00 / 2.5	-	-	OR 325T	33.0	510	1615	725	4871	598	10
18.00 - 25	DockMaster+	E-4	TL	207	A5	40	13.00 / 2.5	-	-	OR 325T	59.0	512	1662	774	5061	598	10
21.00 - 25	CraneMaster	E-3	TL	213	A5	40	15.00 / 3.0	-	-	OR 325T	43.0	603	1765	792	-	683	10
21.00 - 25	TerminalMaster V.ply	IND-3	TL	213	A5	40	15.00 / 3.0	-	-	OR 325T	36.0	618	1788	798	5338	685	10

1) At reference load

2) Please contact Continental Technical Customer Service or Sales representative for clarification

Application	Reach Stackers, Counterbalanced Lift Trucks, Loaded Container Handlers, Empty Container Handlers		Rubber Tire Gantry Crane	Straddle/Shuttle Carriers	Ro-Ro Terminal Tractors	Terminal Tractors and Trailers	Automated Guided Vehicles (AGVs)	Sider Loader (Fork lift/Reach stacker)	Towbar Airport Tractor	Towbarless airport tractor	Small Ground Support Airport Tractor	Hot slag transporter	Heavy lift transport	Other vehicles	
	Load Wheel	Steer Wheel													
Cycle Length (one way) km	1,6		0,6	2,5	2,5	2,5	1,6	1,6	7,0	7,0	2,0	3,0	10,0	Please consult Continental	
Max. laden speed (km/h)	25		8	35	20	40	25	30	32	32	30	15	3		
Cyclic Load	Yes		Yes	Yes	Yes	Yes	Yes	Yes	No	Yes	No	Yes	No		
Speed	Load(kgJ)														Size
Static	26250	21000	2)	0	22750	22750	26250	26250	17500	26250	17500	26250	26250	26250	18.00 - 25
1	22750	18375	2)	0	22750	22750	22750	20125	17500	22750	17500	22750	22750	22750	
5	22750	18375	2)	0	22750	22750	22750	20125	17500	22750	17500	22750	22750	22750	
10	22750	18375	2)	0	22750	22750	22750	20125	17500	22750	17500	22750	18375	22750	
20	22750	17500	2)	0	19690	19690	22750	19250	17500	17500	17500	17500	17500	17500	
25	22750	17500	2)	0	19690	19690	22750	17500	17500	17500	17500	17500	17500	17500	
35	21875	16190	2)	0	17500	17500	0	16190	16190	16190	16190	16190	0	16190	
40	0	0	2)	0	17500	17500	0	0	0	0	0	0	0	15575	
50	0	0	2)	0	0	0	0	0	0	0	0	0	0	14700	
Static	2)	2)	26250	0	2)	2)	2)	2)	2)	2)	2)	2)	2)	2)	18.00 - 25
1	2)	2)	22750	0	2)	2)	2)	2)	2)	2)	2)	2)	2)	2)	
5	2)	2)	22750	0	2)	2)	2)	2)	2)	2)	2)	2)	2)	2)	
10	2)	2)	22750	0	2)	2)	2)	2)	2)	2)	2)	2)	2)	2)	
20	2)	2)	22750	0	2)	2)	2)	2)	2)	2)	2)	2)	2)	2)	
25	2)	2)	22750	0	2)	2)	2)	2)	2)	2)	2)	2)	2)	2)	
35	2)	2)	21875	0	2)	2)	2)	2)	2)	2)	2)	2)	2)	2)	
40	2)	2)	0	0	2)	2)	2)	2)	2)	2)	2)	2)	2)	2)	
50	2)	2)	0	0	2)	2)	2)	2)	2)	2)	2)	2)	2)	2)	
Static	26250	21000	0	0	22750	2)	2)	26250	17500	26250	17500	26250	26250	26250	18.00 - 25
1	22750	18375	0	0	22750	2)	2)	20125	17500	22750	17500	22750	22750	22750	
5	22750	18375	0	0	22750	2)	2)	20125	17500	22750	17500	22750	22750	22750	
10	22750	18375	0	0	22750	2)	2)	20125	17500	22750	17500	22750	18375	22750	
20	22750	17500	0	0	19690	2)	2)	19250	17500	17500	17500	17500	17500	17500	
25	22750	17500	0	0	19690	2)	2)	17500	17500	17500	17500	17500	17500	17500	
35	21875	16190	0	0	17500	2)	2)	16190	16190	16190	16190	16190	0	16190	
40	0	0	0	0	17500	2)	2)	0	0	0	0	0	0	15575	
50	0	0	0	0	0	2)	2)	0	0	0	0	0	0	14700	
Static	2)	2)	30900	0	2)	2)	2)	2)	2)	2)	2)	2)	2)	2)	21.00 - 25
1	2)	2)	26780	0	2)	2)	2)	2)	2)	2)	2)	2)	2)	2)	
5	2)	2)	26780	0	2)	2)	2)	2)	2)	2)	2)	2)	2)	2)	
10	2)	2)	26780	0	2)	2)	2)	2)	2)	2)	2)	2)	2)	2)	
20	2)	2)	26780	0	2)	2)	2)	2)	2)	2)	2)	2)	2)	2)	
25	2)	2)	26780	0	2)	2)	2)	2)	2)	2)	2)	2)	2)	2)	
35	2)	2)	25750	0	2)	2)	2)	2)	2)	2)	2)	2)	2)	2)	
40	2)	2)	0	0	2)	2)	2)	2)	2)	2)	2)	2)	2)	2)	
50	2)	2)	0	0	2)	2)	2)	2)	2)	2)	2)	2)	2)	2)	
Static	30900	24720	2)	0	26780	2)	30900	30900	20600	30900	20600	30900	30900	30900	21.00 - 25
1	26780	21630	2)	0	26780	2)	26780	23690	20600	26780	20600	26780	26780	26780	
5	26780	21630	2)	0	26780	2)	26780	23690	20600	26780	20600	26780	26780	26780	
10	26780	21630	2)	0	26780	2)	26780	23690	20600	26780	20600	26780	21630	26780	
20	26780	20600	2)	0	23175	2)	26780	22660	20600	20600	20600	20600	20600	20600	
25	26780	20600	2)	0	23175	2)	26780	20600	20600	20600	20600	20600	20600	20600	
35	25750	19055	2)	0	20600	2)	0	19055	19055	19055	19055	19055	0	19055	
40	0	0	2)	0	20600	2)	0	0	0	0	0	0	0	18335	
50	0	0	2)	0	0	2)	0	0	0	0	0	0	0	17305	

Technical Data Material Handling - OTR V.Ply

Size range, specifications and tire load capacities

Size	Pattern	Tire									Tire dimensions [mm]						
		Tread Code	Tire Type	Code			Recom. rim	Tube	Flap	O-Ring	Article approximate data						
				LI	SSY	PR					Tread depth	Width	Outer dia.	Static ¹⁾ rad.	Rolling ¹⁾ circ.	Min. Dual Spacing	Infl. Press. [bar]
21.00 - 25	TerminalMaster V.ply	IND-3	TL	213	A5	40	15.00 / 3.0	-	-	OR 325T	36.0	618	1788	798	5338	685	10
18.00 - 33	ContainerMaster	E-4	TL	214	A5	40	13.00 / 2.5	-	-	OR 333T	65.0	525	1880	870	-	598	10
18.00 - 33	ContainerMaster+	E-4	TL	214	A5	40	13.00 / 2.5	-	-	OR 333T	65.0	522	1880	863	5673	598	10
21.00 - 35	CraneMaster	E-3	TL	219	A5	40	15.00 / 3.0	-	-	OR 335T	41.0	575	2013	-	-	701	10

1) At reference load

2) Please contact Continental Technical Customer Service or Sales representative for clarification

Application	Reach Stackers, Counterbalanced Lift Trucks, Loaded Container Handlers, Empty Container Handlers		Rubber Tire Gantry Crane	Straddle/Shuttle Carriers	Ro-Ro Terminal Tractors	Terminal Tractors and Trailers	Automated Guided Vehicles (AGVs)	Sider Loader (Fork lift/Reach stacker)	Towbar Airport Tractor	Towbarless airport tractor	Small Ground Support Airport Tractor	Hot slag transporter	Heavy lift transport	Other vehicles	
	Load Wheel	Steer Wheel													
Cycle Length (one way) km	1,6		0,6	2,5	2,5	2,5	1,6	1,6	7,0	7,0	2,0	3,0	10,0	Please consult Continental	
Max. laden speed (km/h)	25		8	35	20	40	25	30	32	32	30	15	3		
Cyclic Load	Yes		Yes	Yes	Yes	Yes	Yes	Yes	No	Yes	No	Yes	No		
Speed	Load[kg]														Size
Static	30900	24720	2)	0	26780	2)	30900	30900	20600	30900	20600	30900	30900	30900	21.00 - 25
1	26780	21630	2)	0	26780	2)	26780	23690	20600	26780	20600	26780	26780	26780	
5	26780	21630	2)	0	26780	2)	26780	23690	20600	26780	20600	26780	26780	26780	
10	26780	21630	2)	0	26780	2)	26780	23690	20600	26780	20600	26780	21630	26780	
20	26780	20600	2)	0	23175	2)	26780	22660	20600	20600	20600	20600	20600	20600	
25	26780	20600	2)	0	23175	2)	26780	20600	20600	20600	20600	20600	20600	20600	
35	25750	19055	2)	0	20600	2)	0	19055	19055	19055	19055	19055	0	19055	
40	0	0	2)	0	20600	2)	0	0	0	0	0	0	0	18335	
50	0	0	2)	0	0	2)	0	0	0	0	0	0	0	17305	
Static	31800	25440	2)	0	27560	27560	31800	31800	21200	31800	21200	31800	31800	31800	18.00 - 33
1	27560	22260	2)	0	27560	27560	27560	24380	21200	27560	21200	27560	27560	27560	
5	27560	22260	2)	0	27560	27560	27560	24380	21200	27560	21200	27560	27560	27560	
10	27560	22260	2)	0	27560	27560	22260	24380	21200	27560	21200	27560	22260	27560	
20	27560	21200	2)	0	23850	23850	21200	23320	21200	21200	21200	21200	21200	21200	
25	27560	21200	2)	0	23850	23850	21200	21200	21200	21200	21200	21200	21200	21200	
35	26500	19610	2)	0	21200	21200	0	19610	19610	19610	19610	19610	0	19610	
40	0	0	2)	0	21200	21200	0	0	0	0	0	0	0	18870	
50	0	0	2)	0	0	0	0	0	0	0	0	0	0	17810	
Static	31800	25440	2)	0	27560	27560	31800	31800	21200	31800	21200	31800	31800	31800	18.00 - 33
1	27560	22260	2)	0	27560	27560	27560	24380	21200	27560	21200	27560	27560	27560	
5	27560	22260	2)	0	27560	27560	27560	24380	21200	27560	21200	27560	27560	27560	
10	27560	22260	2)	0	27560	27560	27560	24380	21200	27560	21200	27560	22260	27560	
20	27560	21200	2)	0	23850	23850	27560	23320	21200	21200	21200	21200	21200	21200	
25	27560	21200	2)	0	23850	23850	27560	21200	21200	21200	21200	21200	21200	21200	
35	26500	19610	2)	0	21200	21200	0	19610	19610	19610	19610	19610	0	19610	
40	0	0	2)	0	21200	21200	0	0	0	0	0	0	0	18870	
50	0	0	2)	0	0	0	0	0	0	0	0	0	0	17810	
Static	2)	2)	36450	0	2)	2)	2)	2)	2)	2)	2)	2)	2)	2)	21.00 - 35
1	2)	2)	31590	0	2)	2)	2)	2)	2)	2)	2)	2)	2)	2)	
5	2)	2)	31590	0	2)	2)	2)	2)	2)	2)	2)	2)	2)	2)	
10	2)	2)	31590	0	2)	2)	2)	2)	2)	2)	2)	2)	2)	2)	
20	2)	2)	31590	0	2)	2)	2)	2)	2)	2)	2)	2)	2)	2)	
25	2)	2)	31590	0	2)	2)	2)	2)	2)	2)	2)	2)	2)	2)	
35	2)	2)	30375	0	2)	2)	2)	2)	2)	2)	2)	2)	2)	2)	
40	2)	2)	0	0	2)	2)	2)	2)	2)	2)	2)	2)	2)	2)	
50	2)	2)	0	0	2)	2)	2)	2)	2)	2)	2)	2)	2)	2)	

Port Operations Tires - Radial



ContainerMaster Radial



- › Excellent transmission of traction forces from vehicle to ground, especially on uneven surfaces and in all weather conditions
- › Innovative tread compound developed to reduce heat build-up for longer distance applications
- › Pre-installed tire sensor to measure tire temperature and air pressure



High mileage and lifetime

Deep tread depth IND-4 with high amount of tread rubber



Increased resistance against FOD

Deep, U-shaped tread grooves ensure easy ejection of stones and foreign objects as the tread moves through the contact patch

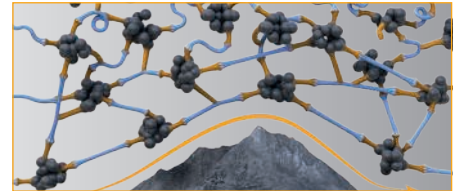

Increased durability

Innovative tread compound for resistance to severe wear and tread cracking caused by stress tears or foreign objects



StraddleMaster Radial



- › Tread design ensures good driving stability and water clearance in wet conditions
- › Long lifetime due to deep tread (E4), innovative tread compound combined with interlinked tread ribs leads to minimized tread movement and low wear Abrasion. Pre-installed tire sensor to measure tire temperature and air pressure

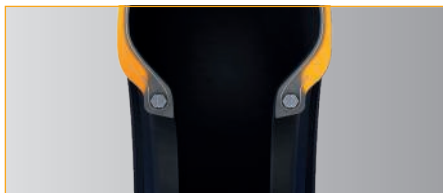

High degree of steering precision with driver comfort

Central tire rib and closed outside shoulder rib ensure longitudinal driving and cornering stability

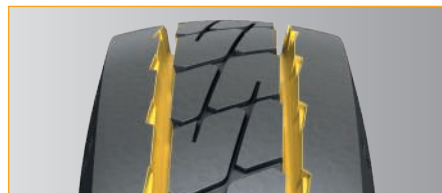

Traction in wet conditions

Deep, wide longitudinal tread grooves provide a high level of water dissipation in wet conditions through contact patch

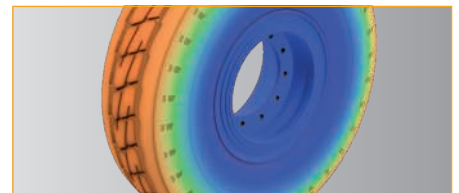

Long tire lifetime and endurance

Innovative tread compound leads to low heat build-up for increased endurance in longer-distance applications

Port Operations Tires - Radial



ContiRT20

- › Excellent transmission of traction forces from vehicle to ground, especially on uneven surfaces
- › High stability due to interlinked tread blocks
- › Pre-installed tire sensor to measure tire temperature and air pressure



Excellent all-round traction on many surfaces and in various climatic conditions

High number of tread edges and multiple tread edges grip ground surface



Good transmission of tractive force with high mileage

Large, robust tread blocks with linked tie bars improve transmission of tractive force and increase mileage

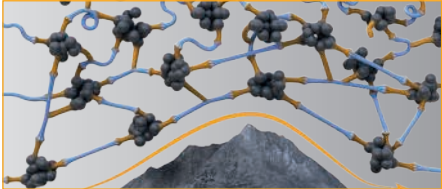

High durability

Innovative tread compound leads to resistance to severe wear and tread cracking

Technical Data Material Handling - OTR Radial

Size range, specifications and tire load capacities

Tire										Tire dimensions [mm]						
Size	Pattern	Code								Article approximate data						
		Tread Code	Tire Type	LI	SSY	Recom. rim	Tube	Flap	O-Ring	Tread depth	Width	Outer dia.	Static ¹⁾ rad.	Rolling ¹⁾ circ.	Min. Dual Spacing	Infl. Press. [bar]
12.00 R 24	ContiRT20	IND-4	TL	178	A5	8.50 / 1.7	-	-	OR325T	40.0	318	1242	571	3901	376	10
12.00 R 24	ContiRT20	IND-4	TT	178	A5	8.50 / 1.7	S 12.00-24 F	220-24	-	40.0	318	1242	571	3901	376	10
14.00 R 24	ContiRT20	IND-4	TL	193	A5	10.00WA	-	-	OR 325 T / OR 324 T	65.0	386	1415	638	4268	465	10
14.00 R 24	ContiRT20	IND-4	TT	193	A5	10.00 WA	S 14.00-24 F	B 260-24	-	65.0	386	1415	638	4268	465	10
14.00 R 24	ContiRT20	IND-4	TT	193	A5	10.0 - 24	S 14.00-24 F	B 260-24	-	65.0	386	1415	638	4268	465	10

1) At reference load

2) Please contact Continental Technical Customer Service or Sales representative for clarification

Application	Reach Stackers, Counterbalanced Lift Trucks, Loaded Container Handlers, Empty Container Handlers		Rubber Tire Gantry Crane	Straddle/Shuttle Carriers	Ro-Ro Terminal Tractors	Terminal Tractors and Trailers	Automated Guided Vehicles (AGVs)	Sider Loader (Fork lift/Reach stacker)	Towbar Airport Tractor	Towbarless airport tractor	Small Ground Support Airport Tractor	Hot slag transporter	Heavy lift transport	Other vehicles	
	Load Wheel	Steer Wheel													
Cycle Length (one way) km	1,6		0,6	2,5	2,5	2,5	1,6	1,6	7,0	7,0	2,0	3,0	10,0	Please consult Continental	
Max. laden speed (km/h)	25		8	35	20	40	25	30	32	32	30	15	3		
Cyclic Load	Yes		Yes	Yes	Yes	Yes	Yes	Yes	No	Yes	No	Yes	No		
Speed	Load(kgJ)														Size
Static	11250	9000	0	0	9750	9750	2)	11250	7500	11250	7500	11250	11250	11250	12.00 R 24
1	9750	7875	0	0	9750	9750	2)	8625	7500	9750	7500	9750	9750	9750	
5	9750	7875	0	0	9750	9750	2)	8625	7500	9750	7500	9750	9750	9750	
10	9750	7875	0	0	9750	9750	2)	8625	7500	9750	7500	9750	7875	9750	
20	9750	7500	0	0	8440	8440	2)	8250	7500	7500	7500	7500	7500	7500	
25	9750	7500	0	0	8440	8440	2)	7500	7500	7500	7500	7500	7500	7500	
35	9375	6940	0	0	7500	7500	2)	6940	6940	6940	6940	6940	0	6940	
40	0	0	0	0	7500	7500	2)	0	0	0	0	0	0	6675	
50	0	0	0	0	0	0	2)	0	0	0	0	0	0	6300	
Static	11250	9000	0	0	9750	9750	2)	11250	7500	11250	7500	11250	11250	11250	12.00 R 24
1	9750	7875	0	0	9750	9750	2)	8625	7500	9750	7500	9750	9750	9750	
5	9750	7875	0	0	9750	9750	2)	8625	7500	9750	7500	9750	9750	9750	
10	9750	7875	0	0	9750	9750	2)	8625	7500	9750	7500	9750	7875	9750	
20	9750	7500	0	0	8440	8440	2)	8250	7500	7500	7500	7500	7500	7500	
25	9750	7500	0	0	8440	8440	2)	7500	7500	7500	7500	7500	7500	7500	
35	9375	6940	0	0	7500	7500	2)	6940	6940	6940	6940	6940	0	6940	
40	0	0	0	0	7500	7500	2)	0	0	0	0	0	0	6675	
50	0	0	0	0	0	0	2)	0	0	0	0	0	0	6300	
Static	17250	13800	0	0	14950	14950	2)	17250	11500	17250	11500	17250	17250	17250	14.00 R 24
1	14950	12075	0	0	14950	14950	2)	13225	11500	14950	11500	14950	14950	14950	
5	14950	12075	0	0	14950	14950	2)	13225	11500	14950	11500	14950	14950	14950	
10	14950	12075	0	0	14950	14950	2)	13225	11500	14950	11500	14950	12075	14950	
20	14950	11500	0	0	12940	12940	2)	12650	11500	11500	11500	11500	11500	11500	
25	14950	11500	0	0	12940	12940	2)	11500	11500	11500	11500	11500	11500	11500	
35	14375	10640	0	0	11500	11500	2)	10640	10640	10640	10640	10640	0	10640	
40	0	0	0	0	11500	11500	2)	0	0	0	0	0	0	10235	
50	0	0	0	0	0	0	2)	0	0	0	0	0	0	9660	
Static	17250	13800	0	0	14950	14950	2)	17250	11500	17250	11500	17250	17250	17250	14.00 R 24
1	14950	12075	0	0	14950	14950	2)	13225	11500	14950	11500	14950	14950	14950	
5	14950	12075	0	0	14950	14950	2)	13225	11500	14950	11500	14950	14950	14950	
10	14950	12075	0	0	14950	14950	2)	13225	11500	14950	11500	14950	12075	14950	
20	14950	11500	0	0	12940	12940	2)	12650	11500	11500	11500	11500	11500	11500	
25	14950	11500	0	0	12940	12940	2)	11500	11500	11500	11500	11500	11500	11500	
35	14375	10640	0	0	11500	11500	2)	10640	10640	10640	10640	10640	0	10640	
40	0	0	0	0	11500	11500	2)	0	0	0	0	0	0	10235	
50	0	0	0	0	0	0	2)	0	0	0	0	0	0	9660	
Static	17250	13800	0	0	14950	14950	2)	17250	11500	17250	11500	17250	17250	17250	14.00 R 24
1	14950	12075	0	0	14950	14950	2)	13225	11500	14950	11500	14950	14950	14950	
5	14950	12075	0	0	14950	14950	2)	13225	11500	14950	11500	14950	14950	14950	
10	14950	12075	0	0	14950	14950	2)	13225	11500	14950	11500	14950	12075	14950	
20	14950	11500	0	0	12940	12940	2)	12650	11500	11500	11500	11500	11500	11500	
25	14950	11500	0	0	12940	12940	2)	11500	11500	11500	11500	11500	11500	11500	
35	14375	10640	0	0	11500	11500	2)	10640	10640	10640	10640	10640	0	10640	
40	0	0	0	0	11500	11500	2)	0	0	0	0	0	0	10235	
50	0	0	0	0	0	0	2)	0	0	0	0	0	0	9660	

Technical Data Material Handling - OTR Radial

Size range, specifications and tire load capacities

Size	Pattern	Tire								Tire dimensions [mm]							
		Tread Code	Tire Type	Code				Tube	Flap	O-Ring	Article approximate data						
				LI	SSY	Recom. rim	Tread depth				Width	Outer dia.	Static ¹⁾ rad.	Rolling ¹⁾ circ.	Min. Dual Spacing	Infl. Press. [bar]	
16.00 R 25	ContainerMaster Radial	IND-4	TL	200	A5	11.25 / 2.0	-	-	OR 325T	63.0	432	1514	678	-	529	10	
450/95 R 25	StraddleMaster Radial	IND-4	TL	204	A5	11.25 / 2.0-25	-	-	OR 325T	52.0	433	1492	660	4500	-	10	
18.00 R 25	ContainerMaster Radial	IND-4	TL	207	A5	13.00 / 2.5	-	-	OR 325T	65.0	516	1639	736	4943	610	10	
18.00 R 25	StraddleMaster Radial	IND-4	TL	207	A5	25-13.00 / 2.5	-	-	OR 325T	45.0	523	1620	695	4886	-	10	
480/95 R 25	StraddleMaster Radial	IND-4	TL	206	A5	13.00 / 2.5	-	-	OR 325T	50.0	472	1538	692	4640	-	10	

1) At reference load

2) Please contact Continental Technical Customer Service or Sales representative for clarification

Application	Reach Stackers, Counterbalanced Lift Trucks, Loaded Container Handlers, Empty Container Handlers		Rubber Tire Gantry Crane	Straddle/Shuttle Carriers	Ro-Ro Terminal Tractors	Terminal Tractors and Trailers	Automated Guided Vehicles (AGVs)	Sider Loader (Fork lift/Reach stacker)	Towbar Airport Tractor	Towbarless airport tractor	Small Ground Support Airport Tractor	Hot slag transporter	Heavy lift transport	Other vehicles	
	Load Wheel	Steer Wheel													
Cycle Length (one way) km	1,6		0,6	2,5	2,5	2,5	1,6	1,6	7,0	7,0	2,0	3,0	10,0	Please consult Continental	
Max. laden speed (km/h)	25		8	35	20	40	25	30	32	32	30	15	3		
Cyclic Load	Yes		Yes	Yes	Yes	Yes	Yes	Yes	No	Yes	No	Yes	No		
Speed	Load[kg]														Size
Static	21000	16800	0	2)	0	0	0	21000	14000	21000	0	21000	21000	21000	16.00 R 25
1	18200	14700	0	2)	0	0	0	16100	14000	18200	0	18200	18200	18200	
5	18200	14700	0	2)	0	0	0	16100	14000	18200	0	18200	18200	18200	
10	18200	14700	0	2)	0	0	0	16100	14000	18200	0	18200	14700	18200	
20	18200	14000	0	2)	0	0	0	15400	14000	14000	0	14000	14000	14000	
25	18200	14000	0	2)	0	0	0	14000	14000	14000	0	14000	14000	14000	
35	17500	12950	0	2)	0	0	0	12950	12950	12950	0	12950	0	12950	
40	0	0	0	2)	0	0	0	0	0	0	0	0	0	12460	
50	0	0	0	2)	0	0	0	0	0	0	0	0	0	11760	
Static	2)	2)	0	17600	0	0	24000	2)	16000	24000	0	24000	24000	24000	450/95 R 25
1	2)	2)	0	17600	0	0	20800	2)	16000	20800	0	20800	20800	20800	
5	2)	2)	0	17600	0	0	20800	2)	16000	20800	0	20800	20800	20800	
10	2)	2)	0	17600	0	0	20800	2)	16000	20800	0	20800	16800	20800	
20	2)	2)	0	17600	0	0	20800	2)	16000	16000	0	16000	16000	16000	
25	2)	2)	0	16000	0	0	20800	2)	16000	16000	0	16000	16000	16000	
35	2)	2)	0	14800	0	0	0	2)	14800	14800	0	14800	0	14800	
40	2)	2)	0	0	0	0	0	2)	0	0	0	0	0	14240	
50	2)	2)	0	0	0	0	0	2)	0	0	0	0	0	13440	
Static	26250	21000	0	0	0	0	0	26250	17500	26250	0	26250	26250	26250	18.00 R 25
1	22750	18375	0	0	0	0	0	20125	17500	22750	0	22750	22750	22750	
5	22750	18375	0	0	0	0	0	20125	17500	22750	0	22750	22750	22750	
10	22750	18375	0	0	0	0	0	20125	17500	22750	0	22750	18375	22750	
20	22750	17500	0	0	0	0	0	19250	17500	17500	0	17500	17500	17500	
25	22750	17500	0	0	0	0	0	17500	17500	17500	0	17500	17500	17500	
35	21875	16190	0	0	0	0	0	16190	16190	16190	0	16190	0	16190	
40	0	0	0	0	0	0	0	0	0	0	0	0	0	15575	
50	0	0	0	0	0	0	0	0	0	0	0	0	0	14700	
Static	2)	2)	0	19250	0	0	26250	2)	17500	26250	0	26250	26250	26250	18.00 R 25
1	2)	2)	0	19250	0	0	22750	2)	17500	22750	0	22750	22750	22750	
5	2)	2)	0	19250	0	0	22750	2)	17500	22750	0	22750	22750	22750	
10	2)	2)	0	19250	0	0	22750	2)	17500	22750	0	22750	18375	22750	
20	2)	2)	0	19250	0	0	22750	2)	17500	17500	0	17500	17500	17500	
25	2)	2)	0	17500	0	0	22750	2)	17500	17500	0	17500	17500	17500	
35	2)	2)	0	16190	0	0	0	2)	16190	16190	0	16190	0	16190	
40	2)	2)	0	0	0	0	0	2)	0	0	0	0	0	15575	
50	2)	2)	0	0	0	0	0	2)	0	0	0	0	0	14700	
Static	2)	2)	0	18700	0	0	25500	2)	17000	25500	0	25500	25500	25500	480/95 R 25
1	2)	2)	0	18700	0	0	22100	2)	17000	22100	0	22100	22100	22100	
5	2)	2)	0	18700	0	0	22100	2)	17000	22100	0	22100	22100	22100	
10	2)	2)	0	18700	0	0	22100	2)	17000	22100	0	22100	17850	22100	
20	2)	2)	0	18700	0	0	22100	2)	17000	17000	0	17000	17000	17000	
25	2)	2)	0	17000	0	0	22100	2)	17000	17000	0	17000	17000	17000	
35	2)	2)	0	15725	0	0	0	2)	15725	15725	0	15725	0	15725	
40	2)	2)	0	0	0	0	0	2)	0	0	0	0	0	15130	
50	2)	2)	0	0	0	0	0	2)	0	0	0	0	0	14280	

Technical Data Material Handling - OTR Radial

Size range, specifications and tire load capacities

Tire										Tire dimensions [mm]						
Size	Pattern	Code								Article approximate data						
		Tread Code	Tire Type	LI	SSY	Recom. rim	Tube	Flap	O-Ring	Tread depth	Width	Outer dia.	Static ¹⁾ rad.	Rolling ¹⁾ circ.	Min. Dual Spacing	Infl. Press. [bar]
18.00 R 33	ContainerMaster Radial	IND-4	TL	214	A5	13.00 / 2.5	-	-	OR 333T	72.0	505	1839	830	5545	598	10
18.00 R 33	StraddleMaster Radial	IND-4	TL	214	A5	33-13.00 / 2.5	-	-	OR 333T	50.0	509	1804	804	5441	-	10

1) At reference load

2) Please contact Continental Technical Customer Service or Sales representative for clarification

Application	Reach Stackers, Counterbalanced Lift Trucks, Loaded Container Handlers, Empty Container Handlers		Rubber Tire Gantry Crane	Saddle/Shuttle Carriers	Ro-Ro Terminal Tractors	Terminal Tractors and Trailers	Automated Guided Vehicles (AGVs)	Sider Loader (Fork lift/Reach stacker)	Towbar Airport Tractor	Towbarless airport tractor	Small Ground Support Airport Tractor	Hot slag transporter	Heavy lift transport	Other vehicles	Size
	Load Wheel	Steer Wheel													
Cycle Length (one way) km	1,6		0,6	2,5	2,5	2,5	1,6	1,6	7,0	7,0	2,0	3,0	10,0	Please consult Continental	
Max. laden speed (km/h)	25		8	35	20	40	25	30	32	32	30	15	3		
Cyclic Load	Yes		Yes	Yes	Yes	Yes	Yes	Yes	No	Yes	No	Yes	No		
Speed	Load[kgJ]														
Static	31800	25440	0	0	0	0	0	31800	21200	31800	0	31800	31800	31800	18.00 R 33
1	27560	22260	0	0	0	0	0	24380	21200	27560	0	27560	27560	27560	
5	27560	22260	0	0	0	0	0	24380	21200	27560	0	27560	27560	27560	
10	27560	22260	0	0	0	0	0	24380	21200	27560	0	27560	22260	27560	
20	27560	21200	0	0	0	0	0	23320	21200	21200	0	21200	21200	21200	
25	27560	21200	0	0	0	0	0	21200	21200	21200	0	21200	21200	21200	
35	26500	19610	0	0	0	0	0	19610	19610	19610	0	19610	0	19610	
40	0	0	0	0	0	0	0	0	0	0	0	0	0	18870	
50	0	0	0	0	0	0	0	0	0	0	0	0	0	17810	
Static	2)	2)	0	23320	0	0	31800	2)	21200	31800	0	31800	31800	31800	18.00 R 33
1	2)	2)	0	23320	0	0	27560	2)	21200	27560	0	27560	27560	27560	
5	2)	2)	0	23320	0	0	27560	2)	21200	27560	0	27560	27560	27560	
10	2)	2)	0	23320	0	0	27560	2)	21200	27560	0	27560	22260	27560	
20	2)	2)	0	23320	0	0	27560	2)	21200	21200	0	21200	21200	21200	
25	2)	2)	0	21200	0	0	27560	2)	21200	21200	0	21200	21200	21200	
35	2)	2)	0	19610	0	0	0	2)	19610	19610	0	19610	0	19610	
40	2)	2)	0	0	0	0	0	2)	0	0	0	0	0	18870	
50	2)	2)	0	0	0	0	0	2)	0	0	0	0	0	17810	



Tubeless Sealing Ring (TSR) Introduction

The Tubeless Sealing Ring (TSR) is a product that enables Continental industrial radial tires to be mounted on standard industrial vehicle rims, which normally require a tube and flap due to the construction. The TSR consists of a rubber ring with an integrated tire inflation valve. The rubber ring sits on the cylindrical part of the rim between the beads of the

tire, and ensures an airtight joint, sealing the tire chamber without the use of a tube and flap.

The TSR facilitates the use of Conti-PressureCheck in combination with a multi-piece rim (tube type). Conti-PressureCheck uses a sensor inside the tire to continuously monitor the inflation pressure and tire temperature

in order to prevent tire failures and damages and maximize fuel efficiency.

The Principle

A rubber sealing ring is mounted inside the tire, between its beads.



Off-center valve position (OC)
for rims with short valve slot.



Standard centered valve position
for rims with long valve slot.



Mounting Steps

See Page 55 for valve details



1 Lubricate the bead area of the tire and the tire interior up to the middle of the sidewall.



2 Fold the TSR in half to create a figure-of-eight, then insert one loop into the tire as far as possible.

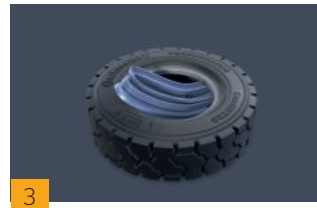

3 Rotate the TSR to line it up with the axis of the tire.



4 Working around the tire, press the TSR into position fully by pushing the TSR wings into the tire. It is very important to ensure that the TSR lies symmetrically inside the tire.



5 Once the TSR is positioned in the tire, lubricate the visible surface of the TSR and the bead area.



6 Lubricate the rim.

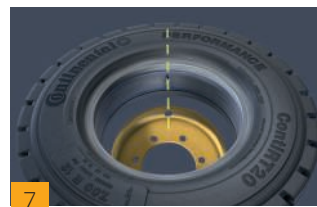

7 Align the rim so that the valve slot is in line with the TSR valve as shown, then drop the tire into position, ensuring that the valve remains centered in the slot.

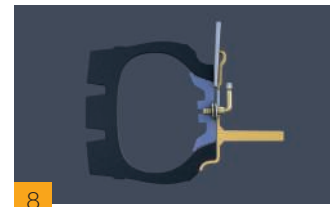

8 Using a lever, push the valve through the valve slot. Be careful not to knock the TSR off-center.

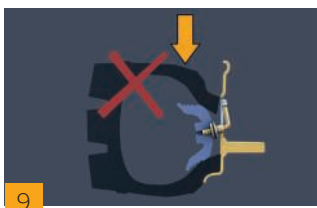

9 Mounted incorrectly (TSR out of position): Do not compress the beads too far, otherwise the TSR may shift out of position and the valve may be damaged.

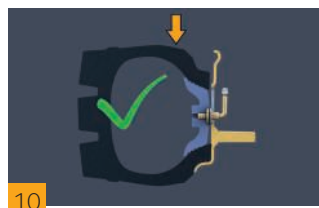

10 Ring mounted correctly: Only push the bead as far as necessary in order to mount the rim rings.

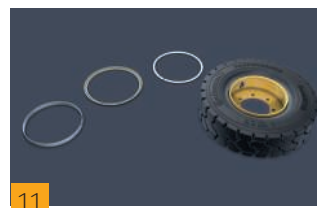

11 Continue to assemble the rim using all the standard rim parts.

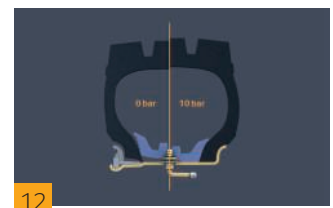

12 Inflate the tire to 1 bar. The valve should be in a centered position. Continue to inflate to 10 bar within an inflation cage, using a remote tire pressure gauge.

TSRs can only be used with Continental industrial radial tires marked **"This tire is compatible with the Continental TSR system"** on the sidewall. Tires with this designation can also be mounted without the TSR system, simply using a tube and flap. The TSR system is not suitable for use with center-split rims or (semi-) drop center rims. A new TSR with a maximum age of 3 years must always be used when mounting a tire. Never re-use a TSR. Do not unscrew the valve to correct the direction of the valve (to match the rim slot). When replacing the valve, make sure that the new valve is screwed on tightly. Attach the wheel to the vehicle according to the vehicle manufacturer's specifications. Tire pressure must be checked 12 hours after TSR fitment. Reinflation may be necessary in order to ensure the correct tire pressure. This is because the TSR may realign itself on the rim after fitting, leading to minor pressure loss.

Valves fitted on TSR

Single-bend valves

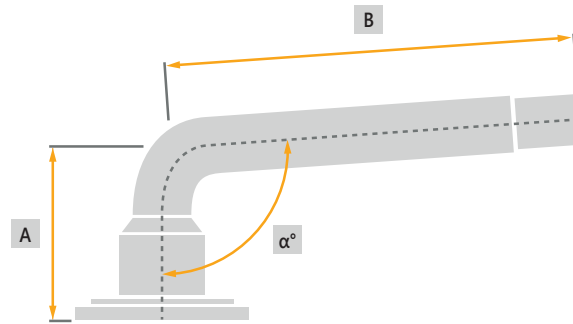

Article No.	Article Designation	A (mm)	B (mm)	α (°)	max. (kPa)
07930020000	TSR 125/75 R 8 TL (3.00)	23.5	25.0	90.0	1050
07930030000	TSR 150/75 - 180/70 R 8 TL (4.33)	23.5	47.5	90.0	1050
07930170000	TSR 5.00 R 8 TL (3.00)	23.5	25.0	90.0	1050
07930330000	TSR 6.00R9 TL (4.00)	23.5	25.0	90.0	1050
07930070000	TSR 225/75 R 10 TL (6.50)	23.5	25.0	90.0	1050
07930050000	TSR 6.50 R 10 TL (5.00)	23.5	25.0	90.0	1050
07930320000	TSR 250/75R12 TL (8.00) OC 30 mm	23.5	60.0	94.0	1050
07930010000	TSR 7.00 R 12 TL (5.00)	23.5	47.5	90.0	1050
07930390000	TSR 7.00 R 12 TL (5.00)	23.5	47.5	90.0	1050
07930290000	TSR 225/75 R 15 TL (6.50) REINF.	23.5	60.0	94.0	1050
07930310000	TSR 250/70 R 15 TL (7.00/7.50) REINF.	23.5	60.0	94.0	1050
07930300000	TSR 315/70 R 15 TL (8.00) REINF.	23.0	105.0	94.0	1050
07930260000	TSR 355/65 R/- 15TL (9.75) REINF.	23.0	105.0	94.0	1050
07930060000	TSR 7.00 R 15 TL (5.50)	23.5	60.0	94.0	1050
07930080000	TSR 7.50 R 15 TL (6.00/6.50)	23.0	70.0	94.0	1050
07930000000	TSR 8.25 R 15 TL (6.50)	23.0	70.0	94.0	1050
07930270000	TSR 20" Radial TL (7.5/8.0/8.5) REINF.	23.0	70.0	94.0	1050
07930380000	TSR 20" Radial TL (7.5/8.0/8.5) REINF. OC 22 mm	23.0	70.0	94.0	1050

double bend valves

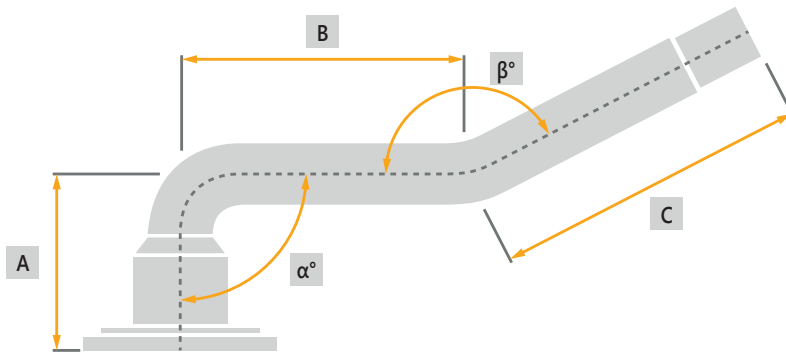

Article No.	Article Designation	A (mm)	B (mm)	C (mm)	α (°)	β (°)	max. (kPa)
7930370000	TSR 20" RADIAL TL (7.5/8.0/8.5) REINF.	23.5	38.5	43.0	90.0	167.0	1050

Tubes - Article Overview

Article Number	Article Description	Valve Code	Valve Offset (mm)
07801010000	21x4, 22x4½ - F	V6.02.1	-
07801020000	23x5, 25x6 - F	V3.02.19	-
07801050000	4.00-8 - F - OC10mm	V6.02.1	10
07801060000	4.00-8 - D	TR 13	-
07801070000	5.00-8 \ 5.00R8 - F - OC10mm	V6.02.1	10
07801100000	16x6, 18x7-8 \ 150/75, 180/70R8 - F	V6.02.1	-
07801110000	16x6, 18x7-8 \ 150/75, 180/70R8 - F	V3.02.19	-
07801120000	6.00, 21x8-9 \ 6.00R9 - F	V6.02.1	-
07801130000	6.00, 21x8-9 \ 6.00R9 - F	V3.02.19	-
07801150000	6.50, 7.50-10 - F - OC10mm	V6.02.1	10
07801160000	6.50, 7.50-10 - F	V3.02.19	-
07801360000	6.50, 7.50-10 - F - OC10mm	V3.02.19	10
07801170000	23x9-10 \ 225/75R10 - F	V3.02.19	-
07801180000	23x9-10 \ 225/75R10 - F	V3.02.27	-
07801190000	7.00-12 \ 7.00R12 - F	V3.02.19	-
07801200000	7.00-12 \ 7.00R12 - F	V3.02.27	-
07801210000	27x10-12 \ 250/75R12 - F - OC30mm	V3.02.19	30
07801350000	27x10-12 \ 250/75R12 - F	V3.02.27	-
07801220000	7.00, 200-15 \ 7.00R15 - F	V3.04.22	-
07801230000	8.25-15 \ 8.25R15 - F	V3.03.3	-
07801240000	8.25-15 \ 8.25R15 - F	V3.04.22	-
07801260000	8.25-15 \ 8.25R15 - F	V3.02.8	-
07801290000	7.50, 8.15, 28x9-15 \ 7.50, 225/75R15 - F	V3.04.22	-
07801300000	7.50, 8.15, 250, 28x9-15 \ 7.50, 250/70, 225/75R15 - F	V3.04.23	-
07801310000	7.50-15 \ 7.50R15 - F	V3.04.23	-
04822010000	5.50-12 Piste	TR 13	25
04822030000	6.3-14 Piste	TR 13	25
07801460000	10.00-20 \ 10.00R20 - F	V3.06.16	-
07801480000	12.00-20 \ 12.00R20 - F	V3.06.16	-
07801490000	12.00-20 \ 12.00R20 - F	V3.06.17	-
07801470000	11.00-20 \ 11.00R20 - F	V3.06.16	-
07801500000	12.00-24 \ 12.00R24 - F	V3.04.25	-
07801510000	12.00-24 \ 12.00R24 - F	V3.06.17	-
07801520000	14.00-24 \ 14.00R24 - F	TR J1175C	-
07801530000	14.00-24 \ 14.00R24 - F	V3.04.21	-
07801090000	15x4½, 125/75-8 - F	V3.02.2	25
07801340000	15x4½, 125/75-8 - F	TR 87	-
07801320000	300, 355/65-15 \ 315/70, 355/65R15 - F	V3.04.23	-
07801330000	300, 355/65-15 \ 315/70, 355/65R15 - F	V3.06.13	-
07801410000	260x85, 3.00, 4.00-4 - F	TR 87	-
07801540000	3.00, 4.00-4 - F	TR 87	-

Tubes - Explanation

Size and Lettering

7.50, 8.15, 250, 28x9-15 / 7.50, 250/70, 225/75R15 - F

6.00, 21x8-9 / 6.00R9 - F

5.00-8 / 5.00R8 - F - **OC10mm**

V3.02.19

6.00-13 **Piste**

Explanation

Tire size/tire construction

Geometry of tube ("F" for "flat" and "d" for deep")

"OC" for off-center and the number for the distance in "mm"

Valve description in line with ETRTO or T and R (beginning with "V" if based on ETRTO and "TR" if based on T and R)

Customer-specific description

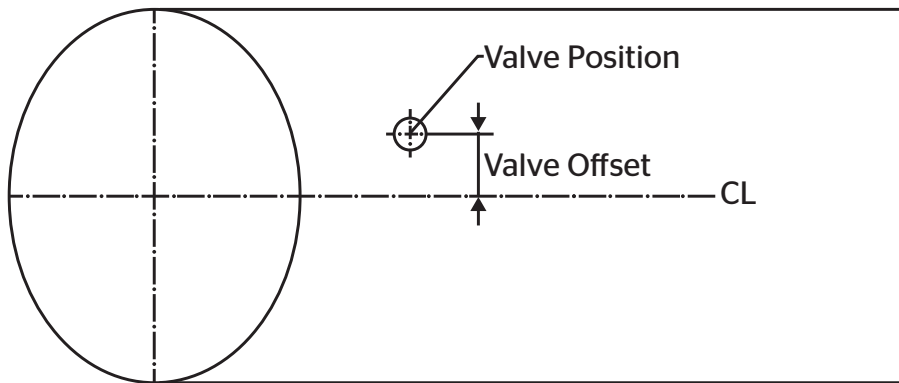

Tubes - Valve Overview

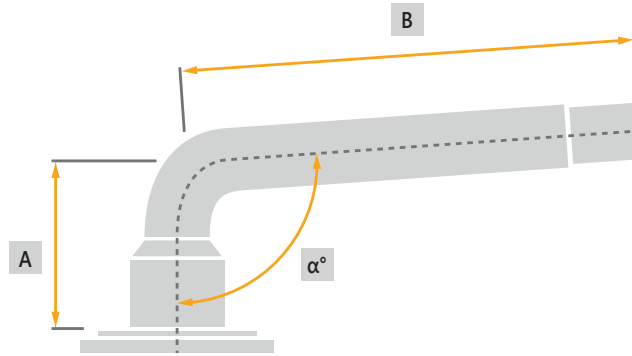

Valve	Standard	A [mm]	B [mm]	α [°]	max. [kPa]
V3.02.2	ETRTO	22.5	43.0	120.0	1050
V3.02.8	ETRTO	20.5	89.5	94.0	1050
V3.02.19	ETRTO	20.5	60.0	94.0	1050
V3.02.27	ETRTO	20.0	75.0	94.0	1050

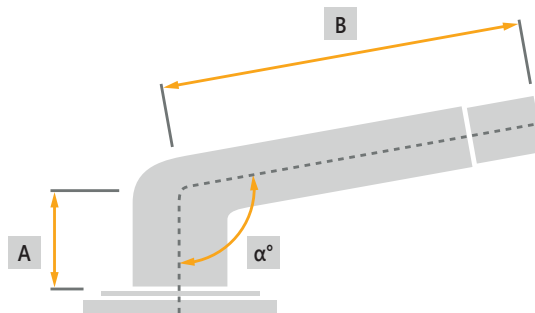

Valve	Standard	A [mm]	B [mm]	α [°]	wmax. [kPa]
V3.03.3	ETRTO	15.5	71.5	94.0	1050

Tubes - Valve Overview

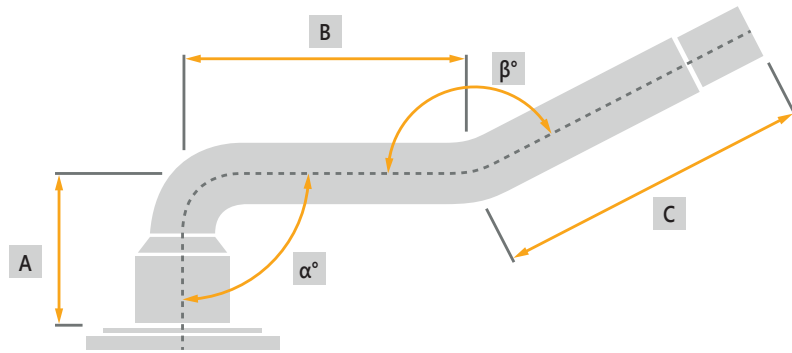

Valve	Standard	A [mm]	B [mm]	C [mm]	α [°]	β [°]	max. [kPa]
V3.04.21	ETRTO	20.0	83.0	57.0	94.0	154.0	1050
V3.04.22	ETRTO	20.0	28.0	47.0	94.0	164.0	1050
V3.04.23	ETRTO	20.0	48.0	47.0	94.0	164.0	1050
V3.04.25	ETRTO	20.0	80.0	47.0	94.0	164.0	1050

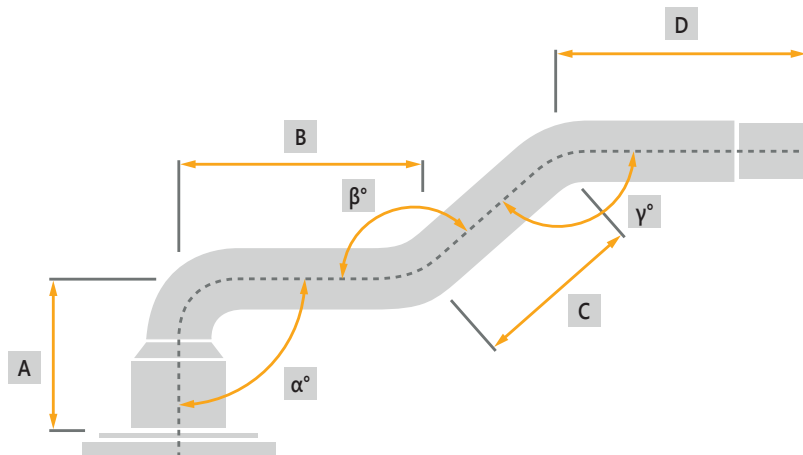

Valve	Standard	A [mm]	B [mm]	C [mm]	D [mm]	α [°]	β [°]	γ [°]	max. [kPa]
V3.06.13	ETRTO	20.0	40.0	13.0	40.0	94.0	153.0	153.0	1050
V3.06.16	ETRTO	20.0	62.0	13.0	50.0	94.0	153.0	153.0	1050
V3.06.17	ETRTO	20.0	75.0	13.0	50.0	94.0	153.0	153.0	1050

Tubes - Valve Overview

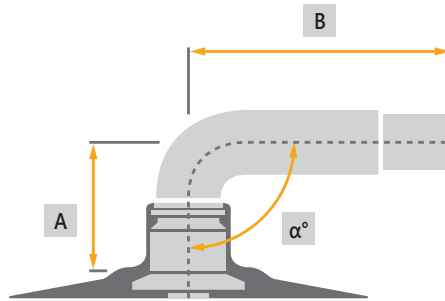

Valve	Standard	A1 [inch]	B1 [inch]	A [mm]	B [mm]	α [°]	max. [kPa]
TR 87	TRA	0,59	1,31	14,99	33,27	90.0	1030

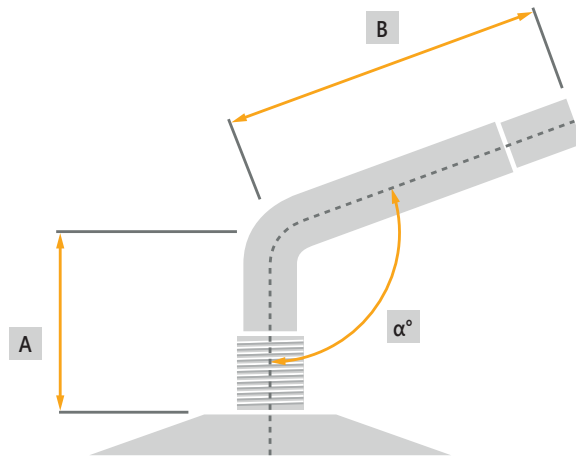

Valve	Standard	A [mm]	B [mm]	α [°]	max. [kPa]
V6.02.1	ETRTO	23.0	41.5	70.0	1050

Tubes - Valve Overview

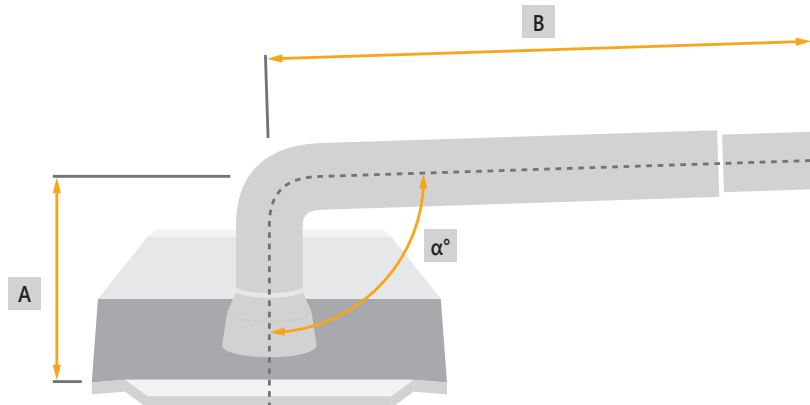
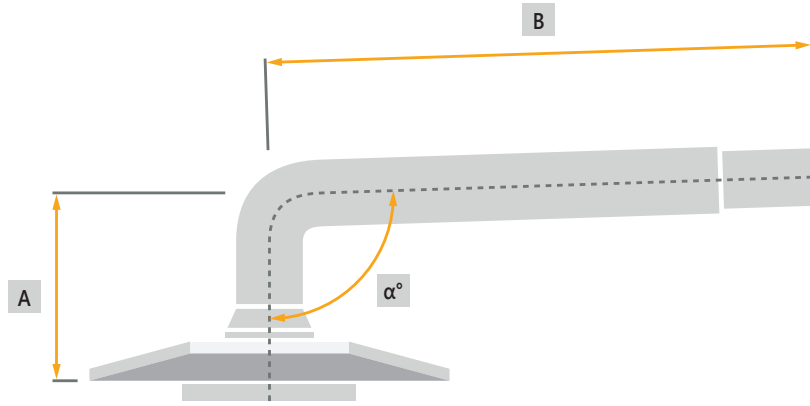

Valve	Standard	A1 [inch]	B [inch]	A [mm]	B [mm]	α [°]	max. [kPa]
TR J1175C	TRA	1.38	4.13 mm	35.05	104.90	88.0	1030

Flaps - Article Overview

Article Number	Article Description (future)	Inner Diameter (mm)	Width [radian] (mm)	Valve Hole Offset (mm)
07903000000	220-24	621.0	217.0	-
07903010000	85-8 - OC10 mm	202.9	104.0	10
07903040000	100-9 - OC10 mm	228.0	116.0	10
07903050000	150-9	228.0	176.0	-
07903060000	130-10	258.0	148.0	-
07903070000	130-10 - OC20 mm	258.0	148.0	20
07903080000	180-10	253.0	166.0	-
07903090000	180-10 - OC10 mm	253.0	166.0	10
07903100000	130-12	305.7	145.0	-
07903110000	220-12 - OC30 mm	299.0	210.0	30
07903250000	85-8	202.9	104.0	-
07903260000	100-9	228.0	116.0	-
07903020000	115-8 Reinf.	212.0	110.8	-
07903130000	100-13	340.0	101.5	-
07903180000	170-15 Reinf.	393.0	170.0	-
07903190000	190-15 Reinf.	393.0	190.0	-
07903200000	190-20 Reinf.	525.0	190.0	-
07903220000	230-20 Reinf.	525.0	230.0	-
07903230000	240-15 Reinf.	393.0	240.0	-
07903350000	220-24 Slot Cover	622.3	212.0	-
07903360000	260-24 Slot Cover	626.6	257.0	-



Flaps - Explanation

Size and Lettering

220-24

220-24 Slot Cover

170-15 Reinf.

220-12 - OC30 mm

Explanation

Flap size (first number is the width in "mm", second number next to "." is the rim diameter in "inches")

Metal plate in valve hole area to cover valve slot

Reinforced with hard rubber/fabrics at valve hole area.

"OC" for off-center and the number for the distance in "mm"

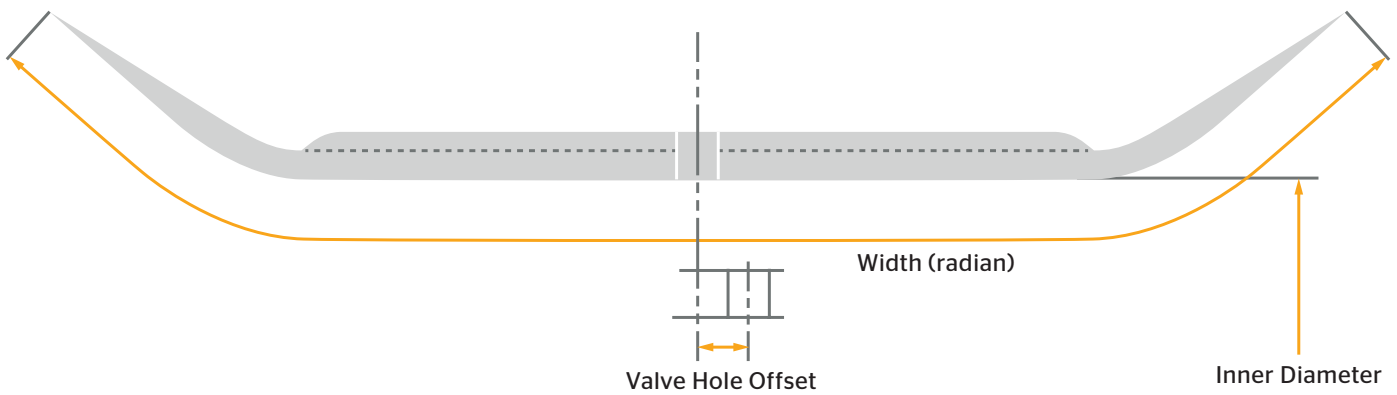

Special Accessories

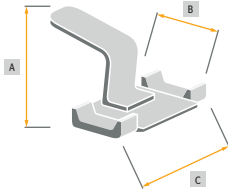
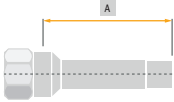
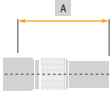
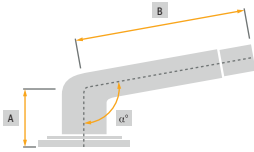
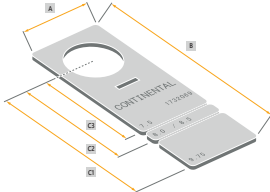
Article No.	Article Description	Used for	
1732501	Valve slot cover plate		
1732054	Valve extension 34 mm	If valve access is difficult due to wheel offset Recommended for most TSR 6.00R9 and TSR 225/75R10 applications.	
1732055	Valve extension 24 mm	If valve access is difficult due to wheel offset.	
1732150	Space-saving valve	For applications with minimal space.	
1732069	Valve slot cover plate 15"/20" TSR	For use with 15" and 20" TSRs for rim widths from 7.0" to 9.75". Supplied along with the TSR. If necessary, the cover plate must be adapted to match the rim width.	

Valve slot cover plate (article no. 1732069)

This plate is designed for use with 15" and 20" TSRs for rim widths of 7.0" to 9.75" and is supplied along with these TSRs. The plate prevents buckling at the valve slot. If necessary, the plate must be shortened at the predetermined break-off points to match the rim width before mounting the TSR. The conventional cover plate (article no. 1732501) can still be used for any other applications.

Don't crimp the valve. Use a TSR with decentered valve in case of a short valve slot.

Valves with special Layouts and Additions

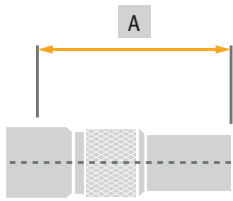

Article No.	Article Designation
17320550000	VALVE EXTENSION 24MM

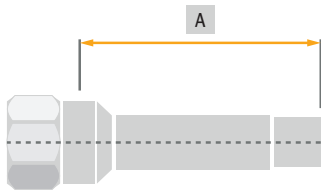

Article No.	Article Designation
17320540000	VALVE EXTENSION 34MM

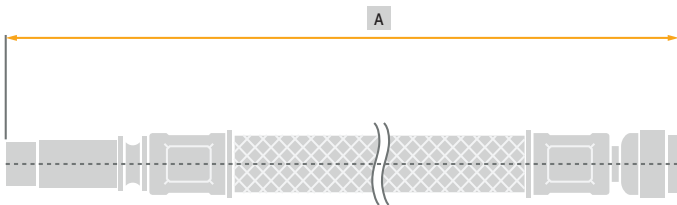

Article No.	Article Designation
12705010000	VALVE EXTENSION 300MM

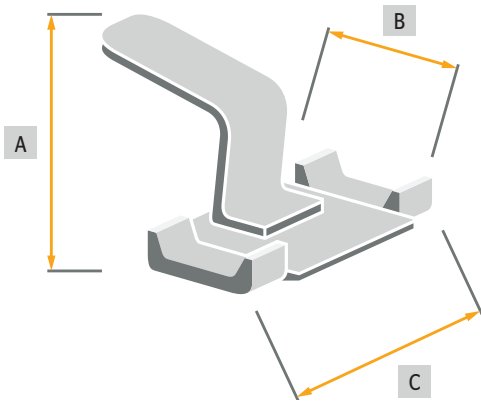

Article No.	Article Designation
17325010000	Valve Slot Cover Plate A 22 mm B 20 mm C 45 mm

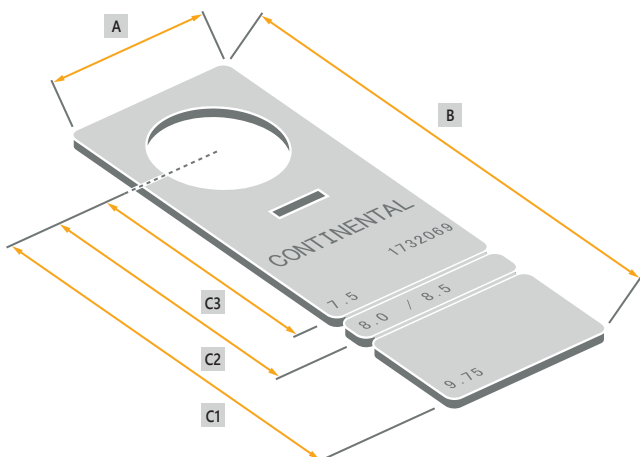

Article No.	Article Designation
17320690000	VALVE SLOT COVER 15"/20" TSR
	A 38 mm
	B 107 mm
Length of cover	C1 87.0 mm
(from valve)	C2 62.5 mm
	C3 54.5 mm

Valves with special Layouts and Additions

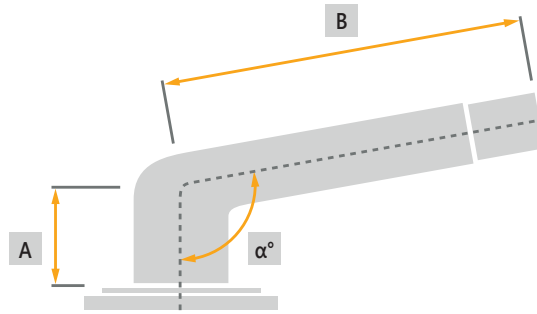

Article No.	Article Designation	Valve	Standard	A [mm]	B [mm]	α [°]	max. [kPa]
17321500000	V3.03.3 FLAT BASE VALVE	V3.03.3	ETRTO	15.5	71.5	94.0	1050

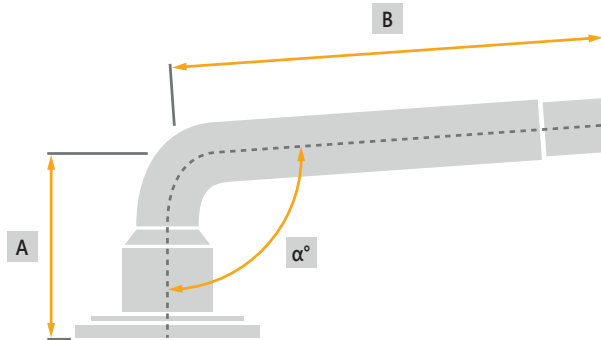

Article No.	Article Designation	Valve	Standard	A [mm]	B [mm]	α [°]	max. [kPa]
17320730000	VALVE 75D-100 V3.02.7	V3.02.7	ETRTO	22.5	71.5	100	1050

O-Ring

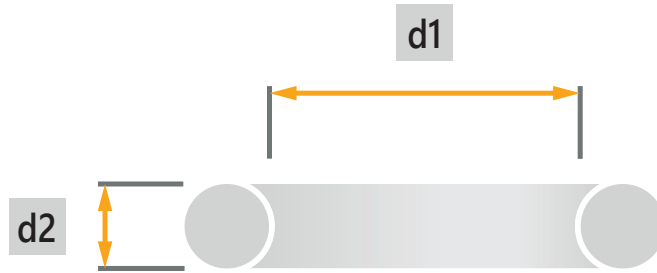

Article No.	Article Designation	d1 (mm)	d2 (mm)
12960390000	OR 220TG O-Ring	463.3	6.6
12960400000	OR 224TG O-Ring	559.4	6.6
12960330000	OR 225T O-Ring	572.5	6.6
12960540000	OR 324T O-Ring	561.5	9.8
12960350000	OR 325T O-Ring	569.6	9.8
12960380000	OR 329T O-Ring	666.6	9.8
12960360000	OR 333T O-Ring	764.6	9.8
12960370000	OR 335T O-Ring	816.2	9.8
12960490000	OR 349T O-Ring	1145.6	9.8

For correct correlation to the rim, see Technical Data Sheet for rim.



Set of SIT Rings for Mounting and Removal



No.	Rim	Tire
1	3.00 D-8	4.00-8 5.00-8 15x4½-8
2	4.33 R-8	16x6-8 18x7-8
3	4.00 E-9 6.00 E-9	6.00-9 21x8-9 140/55-9
4	5.00 F-10 6.50 F-10	6.50-10 23x9-10 180/70-10 200/50-10
5	5.00 S-12	7.00-12
6	8.00 G-12	23x10-12 27x10-12

No.	Rim	Tire
7	3.11 F-13 3.75 P-13	22x4½ 23x5 25x5
8	5.5-15 6.5-15 7.0-15 8.0-15 9.75-15	7.00-15 7.50-15 8.25-15 200-15 28x9-15 250-15 300-15 355/45-15 355/50-15 355/65-15
9	6.50-20 8.0-20 8.5-20 10.0-20	8.25-20 355/50-20 10.00-20 12.00-20



Introduction Digital Tire Monitoring

Managing a fleet of vehicles to ensure the smooth running of a business can be quite a challenging task. Continental offers the technology to help drivers and fleet managers monitor the vehicle's tire condition remotely via any smart device or integrated vehicle systems. This is possible thanks to our intelligent tires

and various digital solutions to ensure that you always operate in optimum conditions, which leads to better safety, efficiency, and tire mileage performance. We offer multiple solutions, ensuring the best fit for each customer's specific operation requirements.



Digital Tire Monitoring - Solutions



Your Challenges in port terminal applications



Lack of time for frequent manual tire checks due to 24/7 shifts.



Maneuvering in tight spaces and a high turn rate place high stress on tires and **can lead to high tire temperatures.**



Driving
Application-based driving behavior.



A wide variety of different processes and applications, both **indoor and outdoor.**



Autonomous vehicles (AGVs) without human monitoring of tire conditions.



Punctures due to debris on ground and damage from other foreign objects.

Solution

- › Receive real-time status updates via e-mail and SMS, or check your tire pressure in the web portal before starting vehicle jobs in order to **reduce risk of breakdowns.**
- › Properly inflated tires **save you up to 1% on fuel** compared to a tire that is underinflated by just 10%. This also increases casing life by up to 20%.*
- › Monitor tire information for your entire fleet in the web portal.
- › Get precise information on your tires' temperature to **help prevent tire damage and breakdowns.**
- › Ensure **correct inflation pressure** during vehicle operations. Get system-supported tire information to increase safety and **save working hours** by eliminating manual pressure checks.

* Please refer to the tire manufacturer's load and inflation information to determine the tire's weight capacity and proper air pressure.

Benefits



Increase efficiency



Monitor your assets



Maximize uptime



Safety



Sustainability



1%
increase in
fuel efficiency¹



15 mins.
saving for
vehicle inspection
(195 hours/year)²



15%
longer tread
life¹

¹ vs. a tire that is 10% underinflated

² Analysis by Continental based on customer experience

Choices



Tire Sensors

Mounted on the inner liner to:
measure pressure and temperature
from inside the tire.

ContiPressureCheck

The perfect single-vehicle solution for monitoring tire pressure and temperature using one of the following options:
hand-held tool, dashboard display or on-board (telematics) system.

ContiConnect Yard

The solution for multiple vehicles that regularly return to dedicated checkpoints. The **Yard Reader Station** collects your vehicles' data wirelessly and transmits it to the ContiConnect web portal.

ContiConnect Live

The perfect solution for remotely monitoring the tire pressure and temperature of multiple vehicles, each equipped with a **Central Telematic Unit** and the CPC system, in real time, wherever they may be. The data is automatically uploaded to the ContiConnect Web portal.

Sensor mounting is designed for use with pneumatic radial tires size 15" or larger in tubeless applications. If you have any further questions regarding sensors (e.g. relating to mounting on cross-ply/bias tires) please contact your local Commercial Specialty Tires (CST) Technical Customer Services or send an e-mail to

Customer Partnership

Continental is a partner of MOL, the Belgian specialist for port tow tractors and trailer solutions.

MOL terminal and RoRo tractors are equipped with intelligent Continental TerminalMaster sensor tires installed ex-works to monitor tire pressure and temperature. The ContiPressureCheck system transmits this information to the driver's dashboard. If the tire pressure reaches a critical level, a jointly developed safety system brakes the tractor engine or even brings the vehicle to a complete stop.



Vehicle Solutions

ContiPressureCheck

Single Vehicle Monitoring

ContiPressureCheck is a system for monitoring tire pressure and air temperature via sensors in the tire, for a single vehicle. This system displays the collected data in the driver's cabin and sends a signal when the tire pressure falls below optimum levels. ContiPressureCheck is a driver-centric system for single vehicles, and can be integrated into third-party telematics solutions by enabling long-distance, wireless data transmission.

ContiConnect

Multiple Vehicle Solution

ContiConnect is a solution that easily connects multiple vehicles and helps fleet managers move from rigid, manual maintenance routines to targeted, on-time maintenance. The tool includes a yard reader/telematic unit that enables remote data collection and Transmission. This information is transmitted to the Continental backend and then uploaded to the ContiConnect web portal. This way, drivers and fleet managers can check the data online, any time and anywhere. Tire problems are identified immediately. Enjoy greater convenience with 24/7, real-time information!

Components needed by solution

Single

- › Display
- › Hand-Held Tool (HHT)
- › Central Control Unit (CCU)
- › Tire sensors

Integrated

- › Hand-Held Tool (HHT)
- › Central Control Unit (CCU)
- › Tire sensors
- › Proprietary in-vehicle telematics integration

Yard

- › ContiConnect Web Portal
- › Hand-Held Tool (HHT)
- › Yard Reader Station (YRS)
- › Tire sensors

Live

- › ContiConnect Web Portal
- › ContiConnect on-site app
- › Hand-Held Tool (HHT)
- › Yard Reader Station (YRS)
- › Central Control Unit (CCU)
- › Central Telematic Unit (CTU)
- › Tire sensors

Heavy Forklift, Empty Container Handler

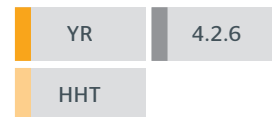

Forklift



Pushback



● Basic Kits CCU, Brackets, Cables, CTU, YR ● Sensor Kits Sensors ● Advanced Kits Display, Cables ● HHT Set Hand-Held Tool
 For a detailed product description and article numbers, please go to page 27.



Reachstacker

1.2	4.2.4	1.2	4.2.4	YR	4.2.6	1.2	CTU
6.2	HHT	7.2	HHT	HHT		4.2.6	6.2



AGV

2.2	4.2.6	YR	4.2.4	2.2	CTU
7.2	HHT	HHT		4.2.4	



Tractor

1.2	4.2.6	1.2	4.2.6	YR	4.2.6	1.2	CTU
6.2	HHT	7.2	HHT	HHT		4.2.6	6.2



Trailer*

3.2	4.2.4	YR	4.2.4	1.2	CTU
HHT		HHT		4.2.4	10.2 / 7.2



RTG*

5.2	4.2.4	5.2	4.2.4	YR	4.2.4	5.2	CTU
6.2	HHT	7.2	HHT	HHT		4.2.4	6.2



Straddle Carrier

5.2	4.2.4	5.2	4.2.4	YR	4.2.4	5.2	CTU
6.2	HHT	7.2	HHT	HHT		4.2.4	6.2

*Please contact our Sales team for detailed information about these and other industrial vehicles.

Components



Display in the driver's cabin

- › Display in the driver's cabin shows the status of the tire and indicates 7 different types of warnings and the related tire position



ContiConnect Web Portal

- › Browser-based web interface for access to data, statistics and reports.



Receiver/Central Control Unit (CCU)

- › Receives and evaluates signals from tire sensors
- › Generates and displays warnings - Up to 24 tires fitted on up to 6 axles



Hand-Held Tool (HHT)

- › Initial configuration of entire system
- › Wireless communication with tire sensors
- › Synchronizes tire sensors to each wheel position
- › Wired communication with CCU



Additional Receiver

- › Integrated antenna and receiver to be used if:
 - › Vehicle has an axle spread of more than 6 m
 - › Vehicle has more than 3 axles
 - › A trailer is docked



Yard Reader Station (YRS)

- › The connectivity component that receives data wirelessly from the tire sensor upon returning to the yard



Telematic Control Unit (TCU)*

- › The Telematic Control Unit receives the processed data from the CCU and transmits it along with a GPS signal to the ContiConnect webportal while the vehicle is moving in operation



Tire Sensor

- › Integrated battery-powered tire sensor with radio frequency transmitter - individual coding for each running wheel
- › Sends data every 2 minutes



Cleaning Scraper and Mounting Tool (for retrofitment of sensor)

- › Scraper for pretreating the inner layer of the tire
- › Pressing tool including insert
- › Tool for pressing on the tire sensor during bonding

	Description	Article No.
● Basic kits	Kit 1.2: Without additional receiver	17 34 115
	Kit 2.2: With additional receiver	17 34 116
	Kit 3.2: Trailer	17 34 117
	Kit 5.2: Coach	17 34 120
● Sensor kits	Kit 4.2.2: 2 tire sensors	17 34 124
	Kit 4.2.4: 4 tire sensors	17 34 118
	Kit 4.2.6: 6 tire sensors	17 34 119
● Advanced kits	Kit 6.2: TireView (display)	17 34 121
	Kit 7.2: TireConnect (telematics cable)	17 34 122
Tire sensor mounting and spare parts	Cleaning scraper	17 34 130
	Mounting tool (tire sensor)	17 34 019
	Insert - mounting tool	17 34 022
	Container tire sensors, set of 12	17 34 072
	Container tire sensors, set of 24	17 34 073
	OTR fixation patch, set of 1	17 34 238
	OTR fixation patch, set of 6	17 34 239
	OTR fixation patch, set of 10	17 34 240
	Spatula	17 34 021
	Glue CB2250 1.6 g	17 34 113
	Glue CB2250 4.8 g	17 34 112
	Glue CB2250 9.6 g	17 34 020
	Sticker and valve cap, set of 2	17 34 123
	Sticker and valve cap, set of 4	17 34 114
Sticker and valve cap, set of 6	17 34 088	
System configuration and spare parts (hand-held tool)	Hand-held tool set, incl. accessory	17 34 052
Spare parts - System	Truck/bus central control unit set	17 34 060
	Bracket (central control unit)	17 34 003
	Trailer central control unit set	17 34 061
	Additional receiver + impact protection	17 34 056
	Impact protection (add. receiver)	17 34 055
	Bracket (additional receiver)	17 34 002
	Sub-harness A	17 34 008
	Sub-harness B	17 34 007
	Sub-harness C	17 34 006
	Sub-harness D	17 34 009
	Sub-harness D - large (13 metres)	17 34 067
	Sub-harness E	17 34 087
	Harness F+G	17 34 016
	Sub-harness H	17 34 017
	Sub-harness K	17 34 070
	Sub-harness L	17 34 069
	Display	17 34 011
	Display holder	17 34 012
	Dashboard display holder	17 34 071
	Pressure check indicator	17 34 013
	Fuse kit F	17 34 036
	Connector kit A+B+C	17 34 018
	Partner Case	Partner case
CPC partner case kit		17 34 135
CPC training box kit		17 34 131
ContiConnect	YardReader Station kit	*
	CTU (Central Telematics Unit)	*

*Please contact our Sales team for detailed information



Product Service and Support

Technical Customer Services

- ▶ Warranty support - from Basic to Advanced
- ▶ Monitoring systems for evaluation and prediction of tire performance
- ▶ Technical consultancy and trainings

Fleet Services

- ▶ Conti360° fleet solutions with a network of around 1,000 service partners in multiple countries across Europe
- ▶ Fleet administration tools to help automate data intake
- ▶ Advanced fleet management back office platform

Sustainability (Targets by 2050)

- ▶ 100% carbon neutrality along our entire value chain
- ▶ 100% emissions-free mobility and industries*
- ▶ Circular economy with 100% closed resource and product cycles
- ▶ 100% responsible value chain
- ▶ Our ambition: 100% renewed and recycled tires

Experts at Work

- ▶ Highly trained employees in every position - from Sales to R&D
- ▶ Close connection to customers in line with our philosophy: "Tire business is people business"
- ▶ Advanced training tools - online, live and hybrid

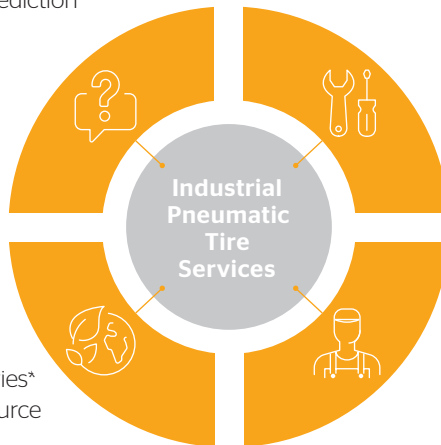

* Emissions-free* defined as zero emissions of gases such as greenhouse gases and NOx; does not include harmless emissions such as water vapor emissions, non-toxic biodegradable particulate emissions, or minimal noise emissions.



Tread Wear Indicator (TWI) and Tread Depth Measurement

Tire wear should always be measured using a proper tire tread depth gauge. The remaining tread depth (RTD) value provides information on the wear ratio, and thus the tire's performance. Please note that the wear is influenced directly by many factors: tire pressure, surface roughness, vehicle weight, tire position, driving style, etc. Because tread wear is not always even, the lowest RTD value must be taken into consideration for safety reasons. For tires used on public roads, check the local minimum RTD regulations. Since Continental Industrial Material Handling and Port Operations products vary in terms of construction type and tread pattern, the remaining tread depth measurement techniques also vary. During measurement the depth gauge must be always kept perpendicular to the tread surface (see picture). When measuring tread depth, always check for signs of tire wear and any signs of abnormal wear or condition. Abnormal wear may be indicative of vehicle maintenance issues, and should be investigated by a tire professional in order to establish the cause. A tire should be replaced if the legal or technical tread depth limit has been reached or exceeded.

Port Operations - V.ply

RTD should be measured in shoulder grooves, where TWI is positioned.



Port Operations - Cross-ply, smooth pattern

RTD should be measured in shoulder grooves, where TWI is positioned.



Port Operations - Radial

RTD should be measured in tread grooves, where TWI is positioned.



Industrial Pneumatic - Cross-ply

Industrial pneumatic bias should be measured in the tread area where marked, see picture.



Industrial Pneumatic - Radial

Industrial pneumatic radial RTD should be measured in the tread grooves, where TWI is positioned.



Solid and Press-on Band

RTD measurement should be down to the 60J line, located on the sidewall.

See the next two pages for further explanations for the wear limit on POB tires.



Press-on Bands (STB)

The wear limits on press-on band tires are connected to the construction of the tire. The damping cushion and tread are adhesively affixed onto the steel base.

① Cut and wear-resistant tread and sidewall

Maximum wear limit

② Steel band

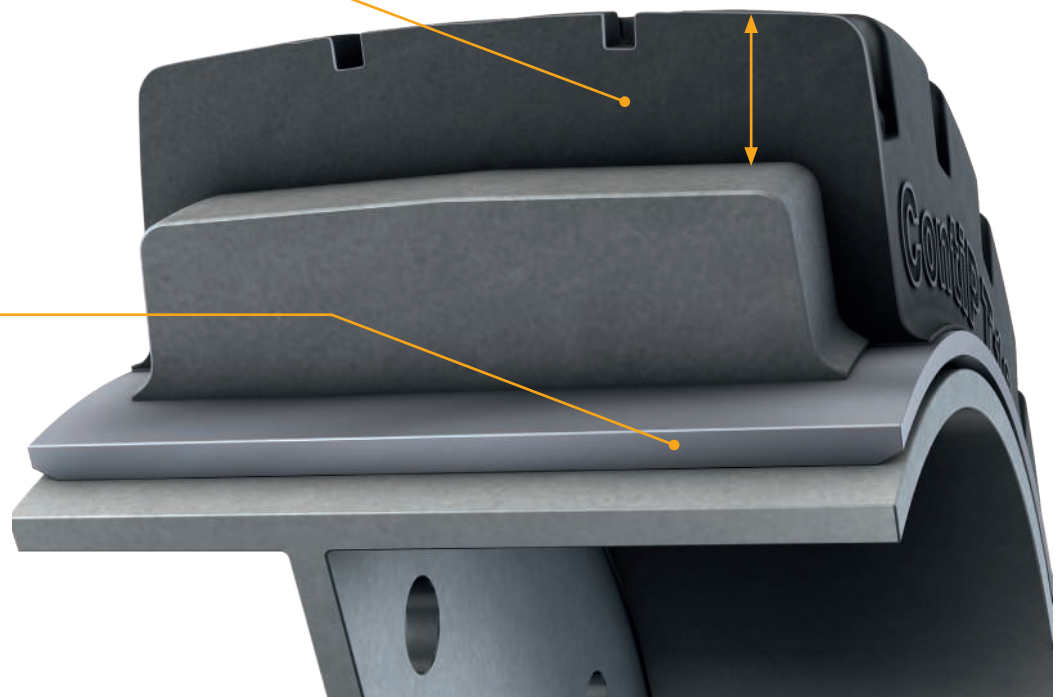

A large part of a press-on band is made from two different rubber compounds to improve performance. The inner structure of the bands consists of a special rubber compound that optimizes the rolling and damping properties as well as heat buildup. Above this is the highly cut and abrasion-resistant tread compound. If the band is worn down further than described above, the inner rubber compound will be exposed.

RTD can be identified using circumferential TWI on both sides.



Tread Depth for Press on Bands

Continental press-on bands for use on industrial vehicles have a usable rubber layer that is approximately one third of the height of the new rubber cushion. We do not recommend driving the bands further than this remaining rubber cushion height.

The calculation formula for cushion height

Cushion height = ((outer diameter x 0.99) - (max. rim diameter)) / 2

A - maximum outer diameter

C - rim outer diameter

$$((A \times 0.99) - C) / 2$$

30% of this result is the usable tread.

For cylindrical POBs, calculate using d0; for tapered POBs, use d1 from the tables below.

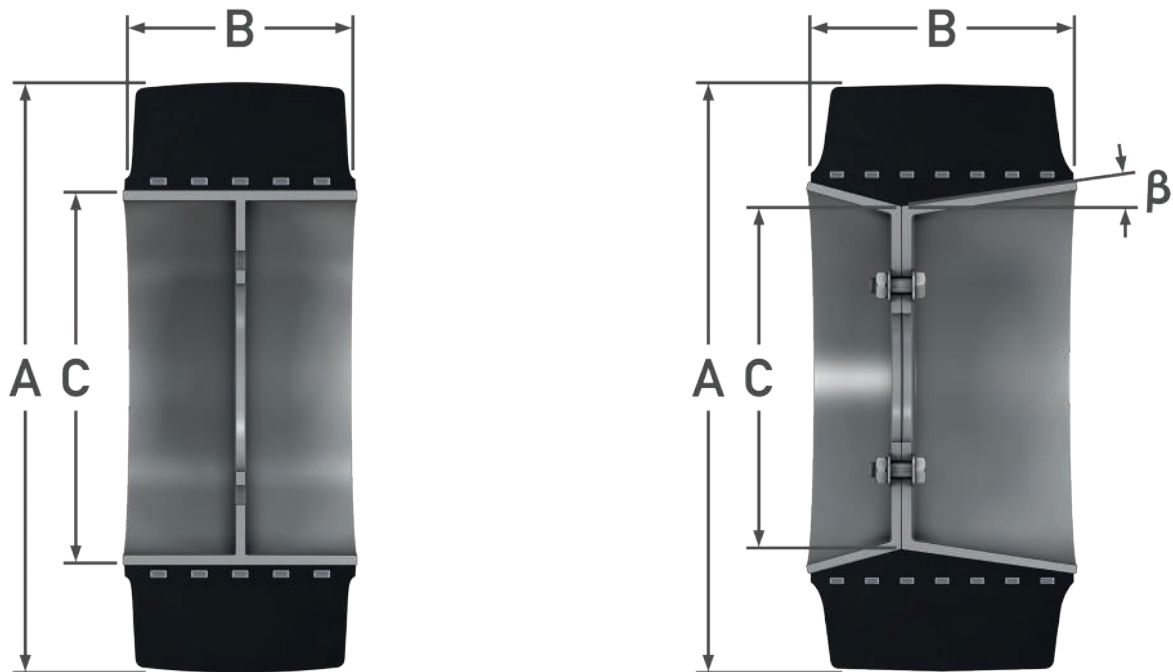

The tables on the following pages provide the usable tread values for each specific PoB size.

Tire Maintenance and Care

POB size			Tapered K (°)		Diameter (mm)			Width (mm)			Cushion	Usable tread
A	B	C	alpha	beta	d0	d1	d2	s0	s1	s2	Height (mm)	Height (mm)
105	45	65			65						19.5	5.8
105	45	65	15		65			67			19.5	5.8
125	50	75			75						24.4	7.3
125	50	75	15		75	88.9		52	26		17.4	5.2
150	38	100	15		100	110.7		40	20		18.9	5.7
150	50	100			100						24.3	7.3
150	50	100	15		100	113.9		52	26		17.3	5.2
160	50	100			100						29.2	8.8
160	50	100	15		100	113.9		52	26		22.3	6.7
160	75	100	15		100	120.9		78	39		18.8	5.6
170	75	100			100						34.2	10.2
180	75	100	15		100	120.9		78	39		28.7	8.6
200	75	100	15		100	120.9		78	39		38.6	11.6
200	85	105			105						46.5	14.0
200	85	105	15		105	128.8		89	44.5		34.6	10.4
180	100	105	8		105	119.6		104	52		29.3	8.8
180	50	120			120						29.1	8.7
180	50	120	15		120	133.9		52	26		22.2	6.6
230	75	120			120						53.9	16.2
230	75	120	51		120	140.9		78	39		43.4	13.0
200	50	140			140						29.0	8.7
200	50	140	15		140	153.9		52	26		22.1	6.6
250	75	140			140						53.8	16.1
250	75	140	15		140	160.9		78	39		43.3	13.0
250	100	140			140			104			53.8	16.1
250	130	140			140			136			53.8	16.1
200	60	150			150			63			24.0	7.2
265	160	160			160			167			51.2	15.4
280	160	160	15	6	160	186	184.9	167	48.5	118.5	45.6	13.7
254	102	165			165						43.2	13.0
254	127	165			165						43.2	13.0
267	127	165			165						49.7	14.9
230	50	170			170						28.9	8.7
230	50	170	15		170	183.9		52	26		21.9	6.6
250	60	170			170						38.8	11.6
250	60	170	15		170	186.9		63	31.5		30.3	9.1
260	60	170			170						43.7	13.1
260	60	170	15		170	186.9		63	31.5		35.3	10.6
230	75	170			170						28.9	8.7
250	75	170	15		170	190.9		78	39		28.3	8.5

POB size			Tapered K (°)		Diameter (mm)			Width (mm)			Cushion	Usable tread
A	B	C	alpha	beta	d0	d1	d2	s0	s1	s2	Height (mm)	Height (mm)
280	75	170	15		170	190.9		78	39		43.2	12.9
250	80	170			170			84			38.8	11.6
300	85	170			170						63.5	19.1
300	85	170	15		170	193.8		89	44.5		51.6	15.5
310	100	170			170			104			68.5	20.5
250	105	170			170			110			38.8	11.6
270	105	170	8		170	185.4		110	55		48.7	14.6
250	50	190			190						28.8	8.6
250	50	190	15		190	203.9		52	26		21.8	6.5
250	60	190			190			63			28.8	8.6
280	60	190			190			63			43.6	13.1
250	85	190			190						28.8	8.6
310	75	200	15		200	220.9		78	39		43.0	12.9
285	100	200	8		200	214.6		104	52		33.8	10.1
310	120	200	15	6	200	219.5	218.6	215	36.5	88.5	43.7	13.1
310	140	200	15	6	200	222.5	221.9	146	42	104	42.2	12.7
330	89	203			203						61.9	18.6
300	90	203			203			94			47.5	14.2
300	100	203			203						47.0	14.1
300	100	203	8		203	217.6		104	52		39.7	11.9
313	130	203	8		203	222.1		136	68		43.9	13.2
330	114	203			203						61.9	18.6
356	114	203			203						74.7	22.4
330	127	203			203						61.9	18.6
343	140	203									169.8	50.9
343	140	203	15	6	203	225.7					56.9	17.1
280	50	220			220						28.6	8.6
280	50	220	15		220	233.9		52	26		21.7	6.5
300	50	220	15		220	233.9		52	26		31.6	9.5
310	60	220			220			63			43.5	13.0
280	75	220	10		220	233.7		78	39		21.8	6.5
285	75	220			220			87			31.1	9.3
300	75	220			220						38.5	11.6
300	75	220	10		220	233.7		78	39		31.7	9.5
310	120	220			220			125			43.5	13.0
405	160	250	15	6	250	276	274.9	167	48.5	118.5	62.5	18.7
406	127	267			267						67.5	20.2
406	127	267	15	6	267	287.6					57.2	17.2
406	152	267			267						67.5	20.2
406	152	267	15	6	267	291.6					55.2	16.6

Tire Maintenance and Care

POB size			Tapered K (°)		Diameter (mm)			Width (mm)			Cushion	Usable tread
A	B	C	alpha	beta	d0	d1	d2	s0	s1	s2	Height (mm)	Height (mm)
406	178	267	15	6	267	295.8					53.1	15.9
360	60	270			270			63			43.2	13.0
360	60	270	15		270	286.7					34.9	10.5
360	75	270			270						43.2	13.0
360	75	270	15		270	290.9		78	39		32.8	9.8
360	85	270			270						43.2	13.0
360	85	270	15		270	293.8		89	44.5		31.3	9.4
381	127	286			286						45.6	13.7
381	152	286			286						45.6	13.7
413	127	286			286						61.4	18.4
413	152	286			286						61.4	18.4
413	178	286			286						61.4	18.4
400	65	305			305			68			45.5	13.7
405	65	305			305			68			48.0	14.4
400	75	305			305						45.5	13.7
400	75	305	15		305	325.9		78	39		35.1	10.5
415	75	305			305			78			52.9	15.9
415	90	305			305						52.9	15.9
415	90	305	15		305	330.2		94	47		40.3	12.1
415	100	305			305						52.9	15.9
415	100	305	8		305	319.6		104	52		45.6	13.7
455	100	305			305			104			72.7	21.8
405	130	305			305			136			48.0	14.4
425	150	305			305			156			57.9	17.4
415	200	305			305						52.9	15.9
405	260	305			305			270			48.0	14.4
425	260	305			305			270			57.9	17.4
425	300	305			305			312			57.9	17.4
450	260	305			305			270			70.3	21.1
450	300	305			305			312			70.3	21.1
432	114	308			308						59.8	18.0
457	127	308			308						72.2	21.7
457	152	308			308						72.2	21.7
457	178	308			308						72.2	21.7
457	178	308	15	6	308	338.8					56.8	17.0
457	203	308			308						72.2	21.7
457	229	308			308						72.2	21.7
533	229	330	15	8	330	378.5					74.6	22.4
420	70	340			340			73			37.9	11.4
500	85	370			370			89			62.5	18.8

POB size			Tapered K (°)		Diameter (mm)			Width (mm)			Cushion	Usable tread
A	B	C	alpha	beta	d0	d1	d2	s0	s1	s2	Height (mm)	Height (mm)
520	100	370			370			104			72.4	21.7
525	120	370			370			125			74.9	22.5
500	125	370			370			130			62.5	18.8
533	127	381			381						73.3	22.0
533	152	381			381						73.3	22.0
533	178	381			381						73.3	22.0
533	203	381			381						73.3	22.0
533	229	381			381						73.3	22.0
533	229	381	15	8	381	425.8					50.9	15.3
559	152	406			406						73.7	22.1
559	203	406			406						73.7	22.1
559	229	406			406						73.7	22.1
559	254	406			406						73.7	22.1
559	305	406			406						73.7	22.1
559	356	406			406						73.7	22.1
559	406	406			406						73.7	22.1
500	65	410			410						42.5	12.8
500	65	410	15		410	428.2		68	34		33.4	10.0
560	100	410			410			104			72.2	21.7
550	120	410			410						67.3	20.2
550	120	410	8		410	427.6		125	62.5		58.5	17.5
590	120	410			410			125			87.1	26.1
610	150	410			410			156			97.0	29.1
550	160	410			410			167			67.3	20.2
540	200	410			410			208			62.3	18.7
620	200	410			410			208			101.9	30.6
645	250	410			410			260			114.3	34.3
645	300	410			410			312			114.3	34.3
645	200	480			480			208			79.3	23.8
645	200	480	15	8	480	519.1					59.7	17.9
645	250	480			480			260			79.3	23.8
670	200	480			480			208			91.7	27.5
760	250	500			500			260			126.2	37.9
711	254	559			559						72.4	21.7
711	305	559			559						72.4	21.7
711	356	559			559						72.4	21.7
711	406	559			559						72.4	21.7
840	356	559			559						136.3	40.9
750	75	640			640			78			51.3	15.4
920	250	670			670			260			120.4	36.1

Contact: If you have any further questions or comments please contact your Continental Sales or Technical Customer Services representative.

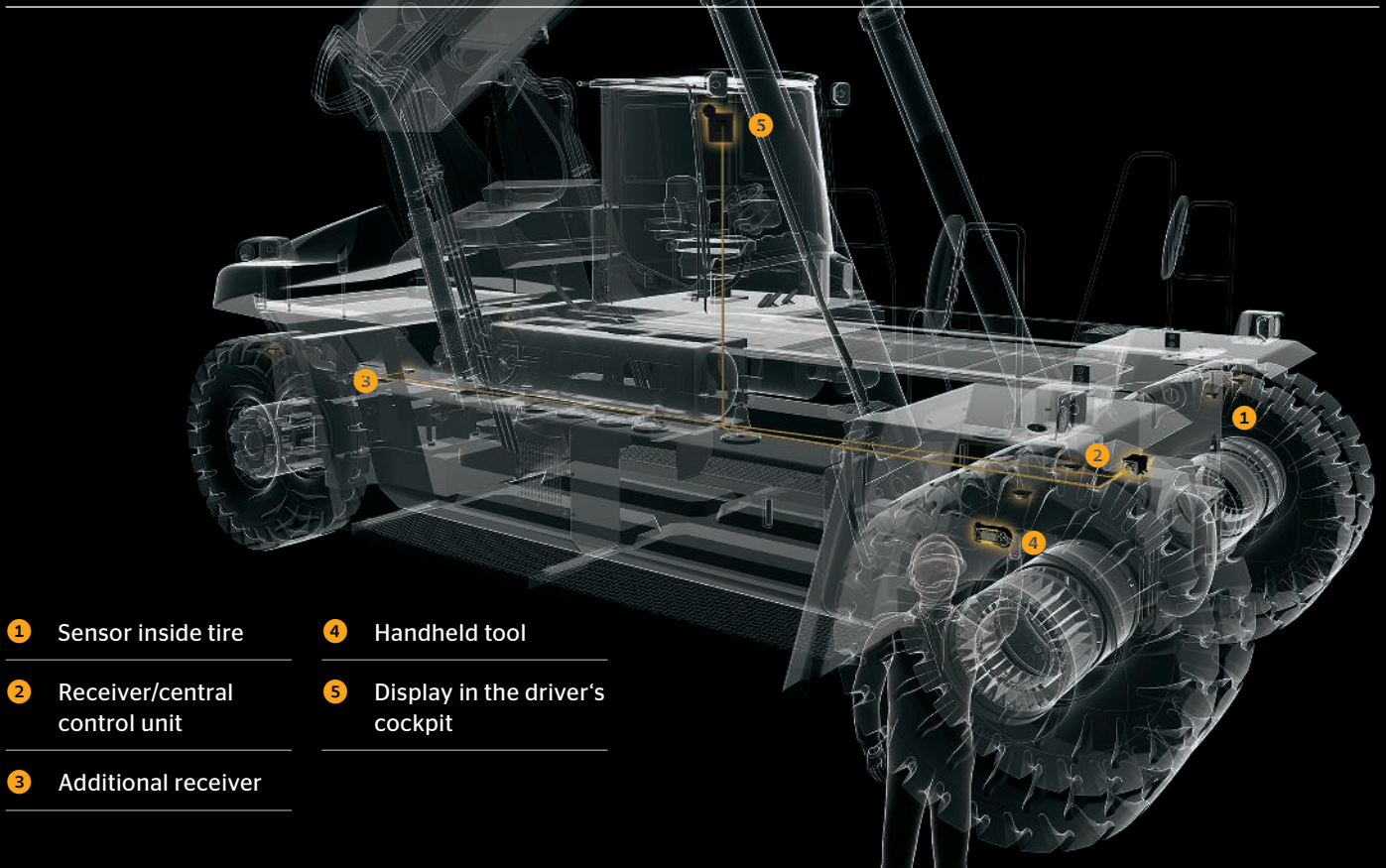

- 1 Sensor inside tire
- 2 Receiver/central control unit
- 3 Additional receiver
- 4 Handheld tool
- 5 Display in the driver's cockpit

Tire Pressure Maintenance

As tires lose pressure naturally, it is important to ensure that tire pressure is checked regularly - either manually or using an automatic tire pressure monitoring system such as ContiPressureCheck or ContiConnect - in order to ensure the correct air pressure is maintained.

A tire operating below the recommended air pressure will experience an increase in operating temperature, which can damage the construction of the tire and, in turn, lead to premature tire failure. An underinflated tire will also increase wear and fuel consumption, while correct tire pressure will ensure a long casing life, thus increasing the casing's chances of being suitable for retreading. When checking tire pressure, it is essential to comply with the vehicle manufacturer's recommendations; the maximum tire pressure defined by the tire manufacturer should not be exceeded. Please note the recommended working condition may vary due to environmental conditions such as air ambient temperature, the application in question and the vehicle the tire is fitted on.

Effects on a tire when operating at incorrect inflation.

- › Based on a 18.00-33 dimension running the tire at 10% below recommended tire pressure would result in an 8% reduction in service life.
- › Costs of underinflation = tire price x 8%
- › Only 92% of the designated life is used.
- › This results in higher expenses for tires, not including the fitment and service costs.

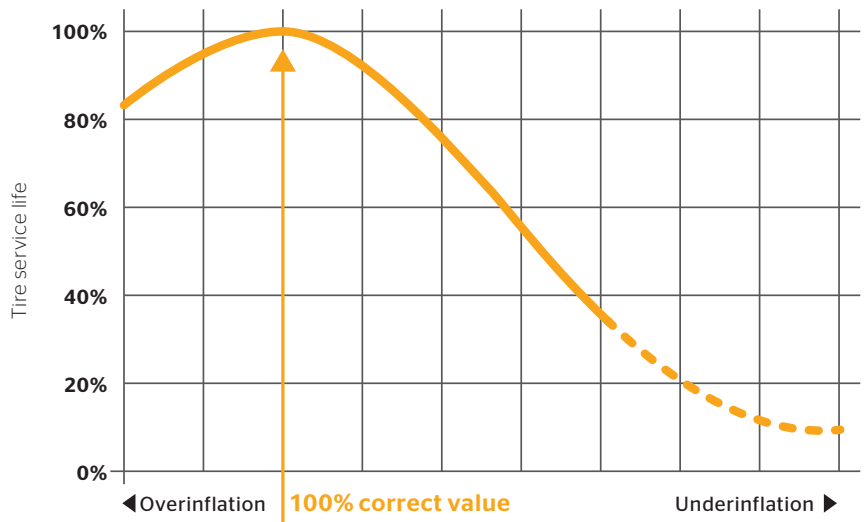



Tire Pressure Maintenance

Correct tire inflation pressure is essential not only to ensure optimum tire performance, but also for safety reasons, as correct pressure keeps vehicle behavior such as braking, road holding and stability consistent. In addition to safety, operators will also notice benefits in terms of increased fuel economy, reduced wear and tear, and lower risks of premature tire failure caused by heat-induced tire deterioration due to over-flexing of the sidewall.

The recommended air pressures are based on the tires being cold, with "cold" being defined as the temperature of the tire after it has been stationary for a period of approximately three hours (25" tire; figures may vary for other diameters). To get an accurate pressure reading, it is therefore essential to ensure that the tires are in this condition when checking the air pressure.

As tires lose pressure naturally during service tire pressure should be checked regularly in order to ensure that it matches the vehicle and/or tire manufacturer's recommended pressure.

Should the tire need to be inflated, the following safety guidelines must be followed:

- › Operators must wear all legally required personal protective equipment, e.g. hard hat, safety goggles, safety boots, gloves, fluorescent safety vest.
- › Operators must also be trained in the correct procedures for measuring tire pressure and inflation - and apply correct procedure at all times.
- › Operators must ensure that the vehicle is stationary and properly secured, e.g. engine switched off, brakes on, blocks engaged on the wheels to ensure the vehicle cannot move.

During inflation, the operator should use an inflation hose and must stand in an appropriate distance to the tire; specifically, the operator should avoid standing parallel to the sidewall in order to ensure they will not be in the blast path should the tire burst. All equipment used should be in good working order.

For further information on tire pressure maintenance and Continental's automatic tire pressure monitoring systems, please contact your local Continental representative.

Regrooving of Solid Tires

After the tread pattern has been worn down, tires are regrooved by removing rubber from the remaining tread to make new grooves. This new tread pattern extends the service life of the tire.

Tires should only be regrooved by qualified persons, and any regrooving must comply with the applicable regulations in the country in which the tire is in use.

Tires should not be regrooved if the tire shows a high level of damage in the remaining tread area (e.g. multiple cuts or missing tire chunks) or the carcass material (belts) is exposed.

When regrooving, it is important to ensure that the correct equipment is used and that operators wear all the legally required personal protective equipment e.g. hard hat, safety goggles, safety boots, gloves, fluorescent safety vest.

For further information on regrooving, please contact your local Continental representative.



To understand the regrooving limit, it is helpful to be familiar with the solid tire construction

Solid tire construction

A solid tire consists of multiple layers of rubber made of different compounds.

Cushion compound

This compound layer provides good damping properties and provides the low rolling resistance that is essential to the overall solid tire performance.

Tread area and sidewall protection

The tread area is exceptionally tough and wear-resistant, giving the tire a long service life.

Tire base

The tire base is made of a hard, tough compound in which the wire cores are embedded, ensuring the tire sits firmly on the rim.

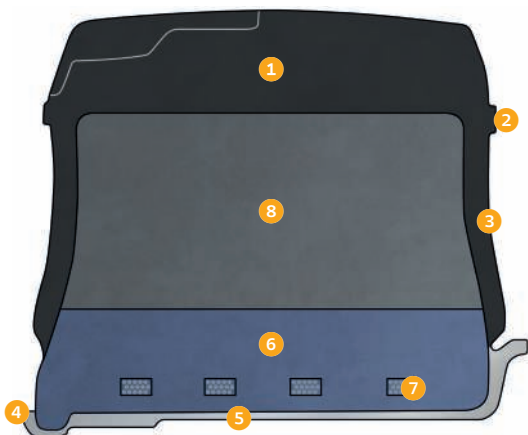

Solid tire construction

- | | |
|-----------------------|--|
| 1 Tread rubber | 6 Base |
| 2 60 joules | 7 Wire core reinforcement |
| 3 Sidewall protection | 8 Highly flexible intermediate layer (cushion) |
| 4 SIT® retainer bead | |
| 5 Rim | |

The regrooving of solid tires provides an advantage in performance on wet and smooth surfaces, like coated, painted or ground concrete floors. In practice, there will be no performance differences when regrooving solid tires for use on other surfaces.

When the original tread pattern is worn down, the tire has reached approximately half its useful service life, depending on size and pattern. In this state of wear, it can remain in service and, if necessary, the tire can be regrooved so that it continues to provide good road holding on wet and dirty surfaces.

The solid tires in the Continental portfolio can be regrooved down to the upper edge of the 60 joule/wear line (tire shoulder), and should not exceed this limit. Regrooving should only be carried out in stages. Only when the tire has once again been worn down should the second stage be performed, in which the remaining tread is regrooved.

Please note: Industrial pneumatic tires must not be regrooved!

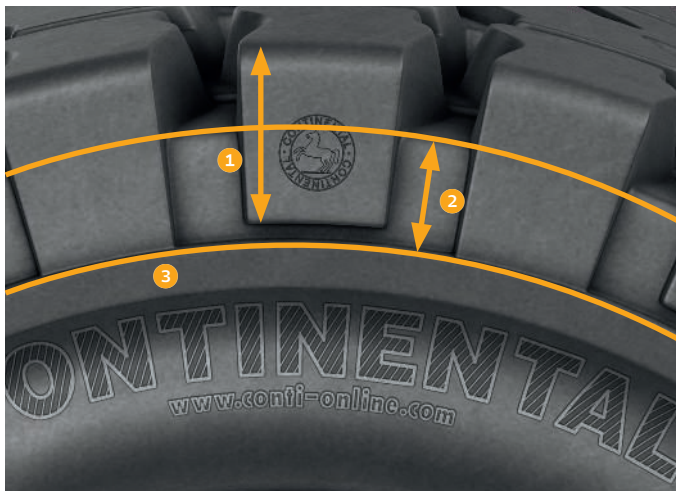

- 1 Tread depth
- 2 Regrooving depth
- 3 60 joule line/maximum wear limit

Positioning of 60 joule line



Solid tire regrooving pattern

Regrooving of Solid Tires

Tire size	B (mm)	S (mm)
3.00-4	7	15
4.00-4	7	15
140/55-6	7	15
4.00-8	7	15
5.00-8	10	20
125/75-8	10	20
150/75-8	15	20
180/70-8	15	20
140/55-9	10	20
6.00-9	10	20
200/75-9	15	30
180/60-10	15	20
6.50-10	15	25
7.50-10	15	30
225/75-10	15	35
200/50-10	15	35
7.00-12	15	30
250/60-12	15	40
315/45-12	20	40
250/75-12	20	40

Tire size	B (mm)	S (mm)
22x4½	10	20
23x5	10	25
25x6	10	25
7.00-15	15	30
7.50-15	15	35
8.25-15	20	35
225/75-15	20	40
355/45-15	25	50
355/50-15	25	50
200/85-15	20	35
250/70-15	20	40
315/70-15	20	45
355/65-15	25	50
355/50-20	25	50
8.25-20	25	40
10.00-20	25	45
12.00-20	25	50
12.00-24	25	50
14.00-24	25	55

Regrooving dimensions by tire size enclosed with this document. Since we are always working to expand our size portfolio, the latest sizes may not always be included in this list. If you have any further questions, please contact your local Continental Technical Customer Services representative or send an e-mail to

Storage and Handling of Tires

It is essential that the handling and storage of Material Handling and Port Operations tires are carried out correctly in order to ensure optimum performance and protect them from damage and exposure to environmental factors that may speed up the aging of the materials in the tire.

Storage

Tires contain a high percentage of natural rubber, which is susceptible to aging over time. This can be accelerated unnecessarily if the tire is not stored correctly.

To prevent tires from aging unnecessarily, they must be stored under specific conditions and for limited amount of time.

As temperature, sunlight, precipitation and humidity can all have a negative effect on tire aging, we recommend storing indoors. However, with larger Port Operations tires, this is not always possible. With this in mind, we have compiled the most important information to consider when storing tires for you below.

When storing tires indoors, it is best to store them in a cool place and in a tidy and organized fashion (e.g. on racks or pallets). Ensure that there is enough space to safely move the tires using handling equipment without any risk of damage. Ideally, tires should be stored upright as this places less stress on them. However they should not be stacked too high due to the risk of tipping.

When storing tires outdoors, ensure that they are not exposed to excessive sunlight (i.e. cover them) or any other form of ozone production such as electric motors, generators or compressors. They should also be stored in a well-drained, preferably paved area, and care should be taken to avoid contact with any material or substance that may cause contamination or is combustible, e.g. solvents, fuels, and lubricants.

Tires can be stored for up to five years after their date of manufacture.

Handling of tires

It is important to use the correct equipment when handling tires in order avoid damage that may compromise the functionality of the tire, which in the worst-case scenario could lead to the tire having to be scrapped. The bead area is particularly susceptible to damage.

For small-diameter tires, we recommend transportation on pallets using material handling equipment (forklifts), ensuring that the forks either lift the tire or grip the outside of the tire's diameter. Under no circumstances should the forks come into contact with the bead area. For larger tires, specialist equipment may an alternative, with rounded booms and tire spreaders especially good options. See below for examples.



For technical details and further information, please check the related Technical Bulletin or the OTR Maintenance Manual.

Rim Types

Tires can only function properly when mounted on the correct rim. There are four main types of rim: single-piece, three-piece, five-piece and press-on-wheel. All rims, however, can come in different formats: flat-based, fully tapered, semi-drop center and drop center. Please note that rims for tubeless tires and tires with tubes may differ.

When mounting rims, it is important to check for defects such as cracks or corrosion, all of which can lead to air leakage and may reduce both traction and braking performance.

Types of rim

Single-Piece

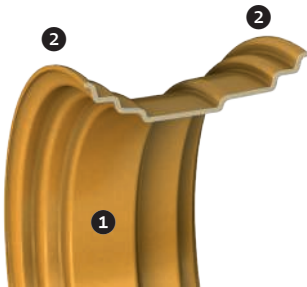

Multi-Piece

3-Piece

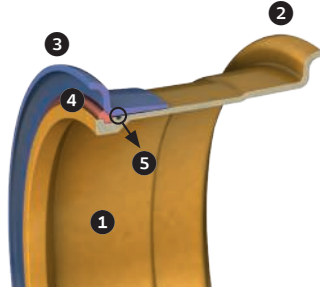

5-Piece

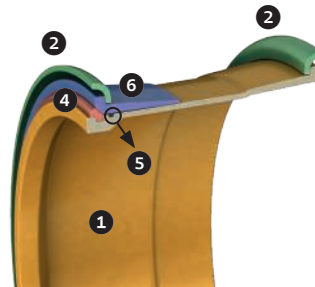

Press-on-Wheel

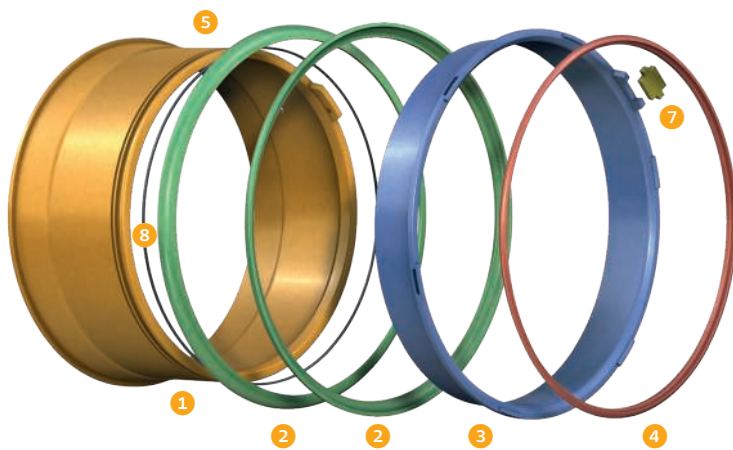
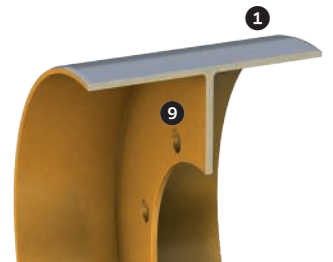

1 Rim base

2 Rim flange

3 Combiring (flange/tapered bead seat ring)

4 Lock ring

5 O-ring groove

6 Tapered bead seat ring

7 Key

8 O-ring

9 Rim disk

Rim Identification

Full tapered bead seat rims

17.00 x 25 - 2 2 - Flange height (inch)
 Or 25 - Nominal rim diameter (inch)
 25 x 17.00 - 2 17.00 - Nominal rim width (inch)

Flat base rims

9.00 V x 24 24 - Rim diameter (inch)
 Or V - Flange identification
 24 x 9.00 V 9.00 - Rim width (inch)

When selecting rims

- › Ensure correct rim width
- › Ensure proper rim components
- › Ensure correct rim diameter and flange height
- › Check for any bent/broken/cracked/rusted components and replace/clean if necessary
- › Check condition of lug nuts and replace if necessary
- › Check studs and replace if necessary
- › Check O-ring condition and replace if necessary (if in doubt, always replace)
- › Check condition of valve and replace if necessary
- › Remove any rust, dirt and any other foreign matter from the ring surface, and especially from the bead seat and O-ring slot
- › Do not attempt to repair any part of the rim that is cracked or damaged
- › **Important: If in doubt, replace!**

Rims for press-on bands acc. to DIN 7845/ETRTO

1. Cylindrical rims “z”

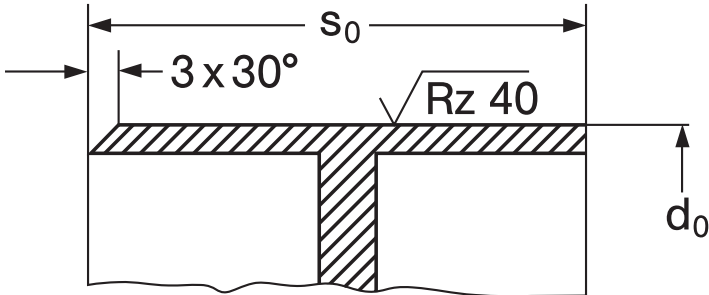

- Rim width** $s_0 > 1.04 \times \text{tire width}$
- Rim diameter** d_0 See tire size

2. Tapered centre-split rims “km”

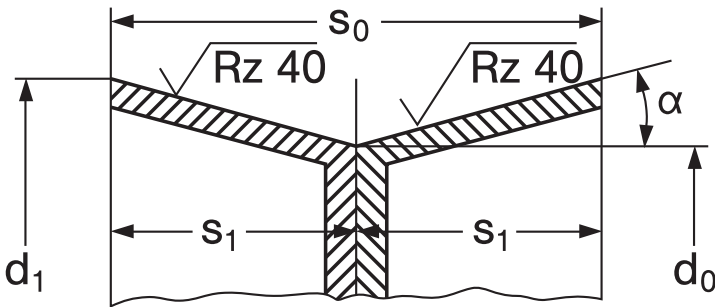

- km 15:** Tire width up to 90 mm ($\alpha = 15^\circ$)
- km 8:** Tire width 91 up to 125 mm ($\alpha = 8^\circ$)
- km 10:** Special sizes ($\alpha = 10^\circ$)
- Rim width** $s_0 > 1.04 \times \text{tire width}$
- Rim width** $s_1 = 0.5 \times \text{rim width } s_0$
- Rim diameter** d_0 See tire size
- Rim diameter** $d_1 = d_0 + (s_0 \times \text{tg } \alpha)$

3. Tapered offset-split rims “ks”

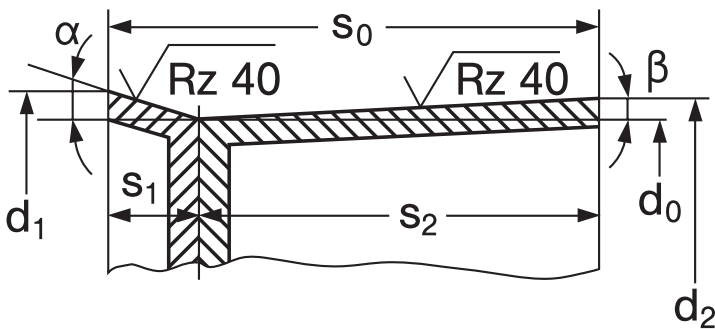

- ks 15/6:** Tire width 126 up to 180 mm ($\alpha = 15^\circ, \beta = 6^\circ$)
- ks 15/8:** Tire width over 180 mm ($\alpha = 15^\circ, \beta = 8^\circ$)
- Rim width** $s_0 > 1.04 \times \text{tire size}$
- Rim width** $s_1 = 0.302 \times \text{tire size}$
- Rim width** $s_2 = 0.738 \times \text{tire size}$
- Rim diameter** d_0 See tire size
- Rim diameter** $d_1 = d_0 + (2 \times s_2 \times \text{tg } \alpha)$
- Rim diameter** $d_2 = d_0 + (2 \times s_2 \times \text{tg } \beta)$

Rims for press-on bands acc. to DIN 7845/ETRTO

4. Rim tolerances

Rim version	Rim diameter tolerance for tires with	
	designation in mm	designation in inches
cylindrical	h 11	+ 0,005" (+ 0.13 mm)
tapered	js 12	js 12

The rims for steel-wire-reinforced press-on bands must always be at least 4% wider than the nominal width of the press-on bands. Rims that are too narrow will cut into the base of the steel-wire-reinforced press-on bands and irreparably damage them.

Round the rim widths up to whole mm.

Rim diameter mm		Tolerance mm	
über	bis	h11	js12
50	80	- 0.190	± 0.150
80	120	- 0.220	± 0.175
120	180	- 0.250	± 0.200
180	250	- 0.290	± 0.230
250	315	- 0.320	± 0.260
315	400	- 0.360	± 0.285
400	500	- 0.400	± 0.315
500	630	- 0.430	-
630	800	- 0.470	-

If two solid press-on bands are pressed onto a single rim, the rim width must be the same as for two single rims.

What is Dual Fitment?

To increase the load carrying capacity of industrial forklifts and counterbalance port handling equipment, tires are fitted on certain heavy load vehicles using dual fitment on the same front axle hub.

This offers the advantage of spreading the heavier load over four tires instead of two. However, it is important to ensure that the sum of the four tires' load indices is sufficient to carry the heavier load.

To ensure irregular tire wear, the vehicles are often fitted with a differential to ensure that the wheels rotate at different speeds, e.g. when cornering.

Dual fitment operation guidelines

When operating a vehicle with dual fitment tires, it is important to ensure the following:

- › The tires must be the same size and have the same construction (either cross-ply or radial; not mixed)
- › The tires must have the same inflation pressure (no more than 1% difference)
- › The tires should have a similar degree of wear
- › When mounting, it is important to fully adhere to the dual spacing distances specified by the tire manufacturer and their recommended tire pressures. Failure to do so can lead to "kissing", whereby the inner tire sidewalls are continually in contact with each other and the continuous friction can lead to the failure of one or both tires.
- › Regularly check for damage to both tires caused by debris being trapped between the two tires.
- › When removing a tire in dual fitment, both tires should be fully deflated.

Rotate tires to increase service life

Dual-fitted tires will develop a joint wear pattern similar to that of a single-fitted tire, i.e. the outside shoulders on the inner and outer tire will wear at a higher rate than the inside shoulders. This can lead to the tires being removed due to the outer shoulder of the tire being worn out. To delay this and to balance the wear across each individual tire, we recommend rotating the tires and turning them on the rim. This will increase the lifetime of dual fitment tires.

Kissing illustration



Kissing on a dual fitment

Wear picture illustration



- 1 Wear
- 2 Outer edge of the dual-tire fitment
- 3 Center-to center distance

REACH, SHVC and Sustainability

EU-REACH Declaration (EC/1907/2006)

The regulation on the Registration, Evaluation, Authorization and Restriction of Chemicals (REACH) is a European Union regulation dated 18 December 2006.

EU Regulation EC/1907/2006 differentiates between roles. Continental is a manufacturer of articles, and not of substances or mixtures. As such, Continental is classed as a “downstream user” pursuant to Article 3.

In particular, Article 33 of the regulation requires downstream users to: inform their customers if an article placed on the European market contains a substance of very high concern (SVHC) of more than 0.1% by weight (SVHCs are listed on the website of the European Chemicals Agency (ECHA) and can be accessed at echa.europa.eu/en/candidate-list-table); not place articles on the market that contain substances that are subject to authorization pursuant to EU REACH Annex XIV if no authorization for the respective application has been granted; and not place articles on the market that contain substances that are restricted pursuant to EU REACH Annex XVII if the application falls under the respective restriction conditions.

Sustainability

Sustainability is an integral part of Continental’s “Vision 2030” strategy program for the Tires group sector, and is anchored in the foundation of our values. Our goal is to be the most progressive tire company in terms of environmental and social responsibility. We relentlessly drive forward innovative technologies and sustainable solutions along our entire value chain, focusing on eight strategic fields of action.

We continually invest in research and development in order drive innovative technologies, alternative and sustainable materials, and environmentally friendly production processes. Our Tires business activities aim to create economic, social and ecological value for all our stakeholders. We want to shape a sustainable future and reduce adverse impacts along the entire value chain using our tires, services and operations.

Continental Reifen Deutschland GmbH
Commercial Specialty Tires
Continental-Plaza 1
30175 Hannover
Germany

